

# MOS FET Relays

# G3VM-353B/B1/E/E1

## Analog-switching MOS FET Relay with SPST-NC Contact. General-purpose Models Added.

- Switches minute AC and DC analog signals.
- General-purpose models (with high ON resistance) added.
- RoHS compliant

### Application Examples

- Electronic automatic exchange systems
- Security systems
- Datacom (modem) systems
- FA systems and Measurement devices

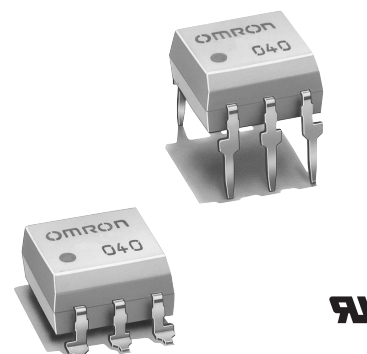

Note: The actual product is marked differently from the image shown here.

### List of Models

Contact form	Terminals	Load voltage (peak value)	Model	Number per stick	Number per tape
SPST-NC	PCB terminals	350 VAC	G3VM-353B	50	---
			G3VM-353B1		
			G3VM-353E		
			G3VM-353E1		
	Surface-mounting terminals		G3VM-353E(TR)	---	1,500
			G3VM-353E1(TR)		

### Dimensions

Note: All units are in millimeters unless otherwise indicated.

#### G3VM-353B/B1

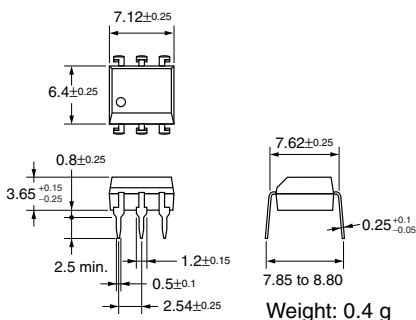
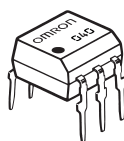

Note: The actual product is marked differently from the image shown here.

#### G3VM-353E/E1

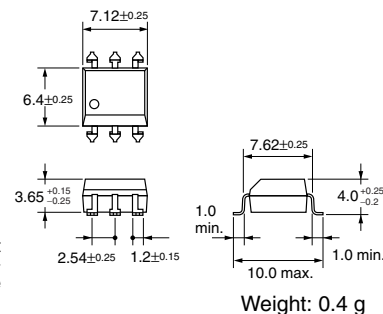
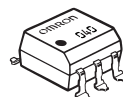

Note: The actual product is marked differently from the image shown here.

### Terminal Arrangement/Internal Connections (Top View)

#### G3VM-353B/B1

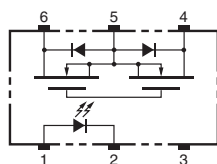

#### G3VM-353E/E1

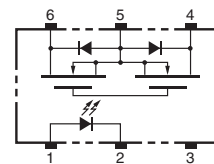

### PCB Dimensions (Bottom View)

#### G3VM-353B/B1

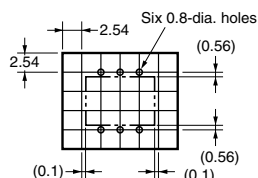

### Actual Mounting Pad Dimensions (Recommended Value, Top View)

#### G3VM-353E/E1

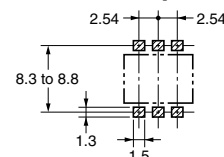

■ Absolute Maximum Ratings (Ta = 25°C)

Item		Symbol	Rating	Unit	Measurement Conditions	
Input	LED forward current	$I_F$	50	mA		
	Repetitive peak LED forward current	$I_{FP}$	1	A	100 $\mu$ s pulses, 100 pps	
	LED forward current reduction rate	$\Delta I_F/^\circ\text{C}$	-0.5	mA/°C	$T_a \geq 25^\circ\text{C}$	
	LED reverse voltage	$V_R$	5	V		
	Connection temperature	$T_j$	125	°C		
Output	Load voltage (AC peak/DC)	$V_{OFF}$	350	V		
	Continuous load current (AC peak/DC)	Connection A	$I_O$	150 (100)	mA	
		Connection B		150 (100)		
		Connection C		300 (200)		
	ON current reduction rate	Connection A	$\Delta I_{ON}/^\circ\text{C}$	-1.5 (-1)	mA/°C	$T_a \geq 25^\circ\text{C}$
		Connection B		-1.5 (-1)		
		Connection C		-3.0 (-2)		
	Connection temperature	$T_j$	125	°C		
Dielectric strength between input and output (See note 1.)		$V_{I-O}$	2,500	$V_{rms}$	AC for 1 min	
Operating temperature		$T_a$	-40 to +85	°C	With no icing or condensation	
Storage temperature		$T_{stg}$	-55 to +125	°C	With no icing or condensation	
Soldering temperature (10 s)		---	260	°C	10 s	

Note: 1. The dielectric strength between the input and output was checked by applying voltage between all pins as a group on the LED side and all pins as a group on the light-receiving side.

Connection Diagram

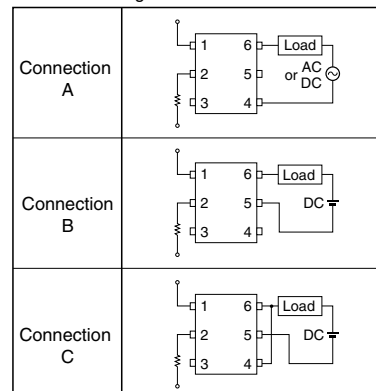

Values in parentheses are for the G3VM-353B1/E1.

■ Electrical Characteristics (Ta = 25°C)

Item		Symbol	Minimum	Typical	Maximum	Unit	Measurement conditions
Input	LED forward voltage	$V_F$	1.0	1.15	1.3	V	$I_F = 10 \text{ mA}$
	Reverse current	$I_R$	---	---	10	$\mu\text{A}$	$V_R = 5 \text{ V}$
	Capacity between terminals	$C_T$	---	30	---	pF	$V = 0, f = 1 \text{ MHz}$
	Trigger LED forward current	$I_{FT}$	---	1	3	mA	$I_{OFF} = 10 \mu\text{A}$
Output	Maximum resistance with output ON	Connection A	$R_{ON}$	15 (27)	25 (50)	$\Omega$	$I_O = 150 \text{ mA (100 mA)}$
		Connection B		8 (20)	14 (43)	$\Omega$	$I_O = 150 \text{ mA (100 mA)}$
		Connection C		4 (10)	7 (---)	$\Omega$	$I_O = 300 \text{ mA (200 mA)}$
	Current leakage when the relay is open	$I_{LEAK}$	---	0.0105 (0.003)	1.0	$\mu\text{A}$	$I_F = 5 \text{ mA}, V_{OFF} = 350 \text{ V}$
	Capacity between terminals A Connection	$C_{OFF}$	---	85 (30)	---	pF	$V = 0, f = 1 \text{ MHz}, I_F = 5 \text{ mA}$
Capacity between I/O terminals		$C_{I-O}$	---	0.8	---	pF	$f = 1 \text{ MHz}, V_s = 0 \text{ V}$
Insulation resistance		$R_{I-O}$	1,000	---	---	$\text{M}\Omega$	$V_{I-O} = 500 \text{ VDC}, R_{OH} \leq 60\%$
Turn-ON time		$t_{ON}$	---	0.1 (0.25)	1.0 (0.5)	ms	$I_F = 5 \text{ mA}, R_L = 200 \Omega, V_{DD} = 20 \text{ V (See note 2.)}$
Turn-OFF time		$t_{OFF}$	---	1.0 (0.5)	3.0 (1)	ms	

Values in parentheses are for the G3VM-353B1/E1.

■ Recommended Operating Conditions

Use the G3VM under the following conditions so that the Relay will operate properly.

Item	Symbol	Minimum	Typical	Maximum	Unit
Load voltage (AC peak/DC)	$V_{DD}$	---	---	280	V
Operating LED forward current	$I_F$	5	---	25	mA
Continuous load current (AC peak/DC)	$I_O$	---	---	150 (100)	mA
Operating temperature	$T_a$	-20	---	65	°C

Values in parentheses are for the G3VM-353B1/E1

Note: 2. Turn-ON and Turn-OFF Times

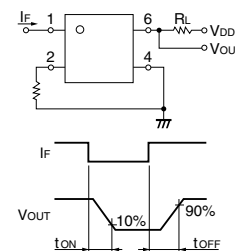

■ Engineering Data

G3VM-353B/E

LED forward current vs. Ambient temperature  
IF - Ta

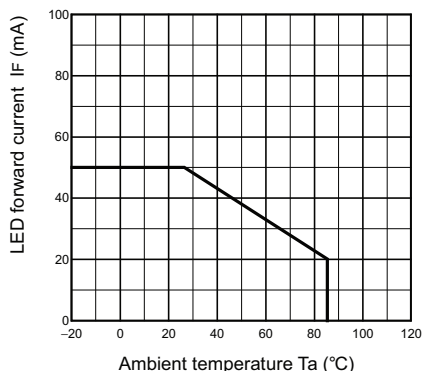

Continuous load current vs. Ambient temperature  
IO - Ta

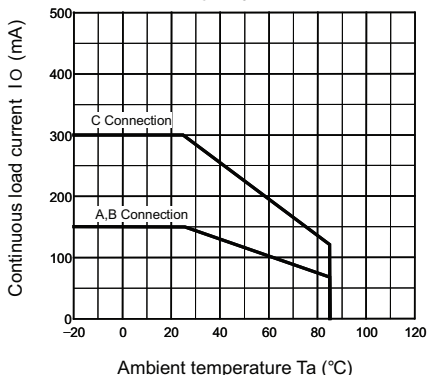

LED forward current vs. LED forward voltage  
IF - VF

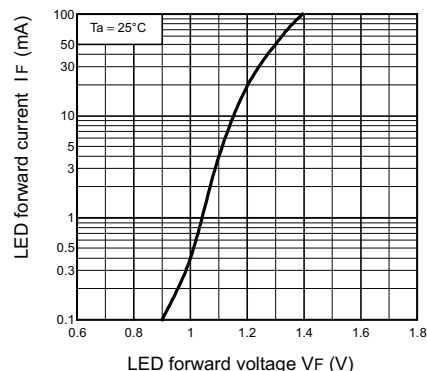

Continuous load current vs. On-state voltage  
IO - VON

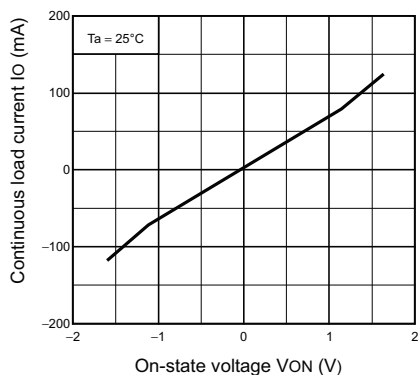

On-state resistance vs. Ambient temperature  
RON - Ta

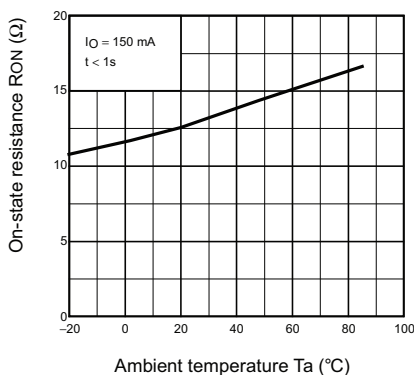

Trigger LED forward current vs. Ambient temperature  
IFC - Ta

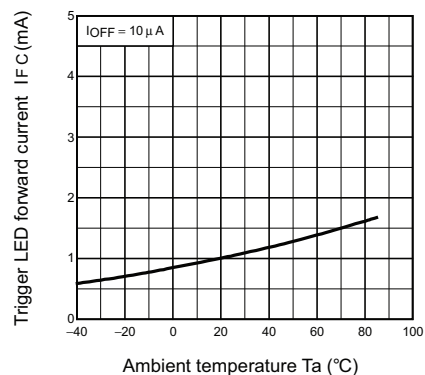

Turn ON, Turn OFF time vs. LED forward current  
tON, tOFF - IF

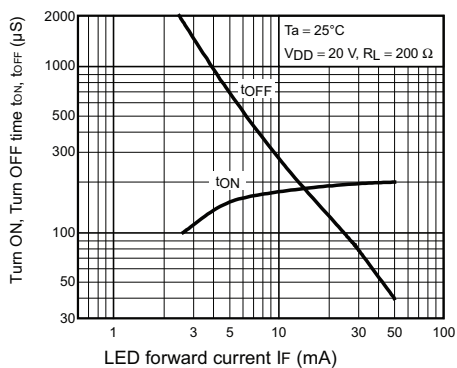

Turn ON, Turn OFF time vs. Ambient temperature  
tON, tOFF - Ta

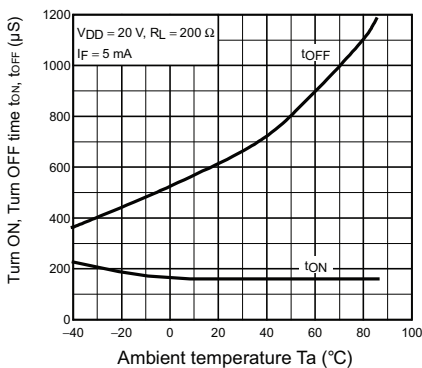

Current leakage vs. Ambient temperature  
ILEAK - Ta

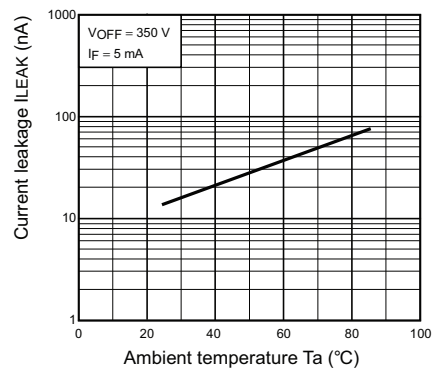

■ Engineering Data

G3VM-353B1/E1

LED forward current vs. Ambient temperature  
IF - Ta

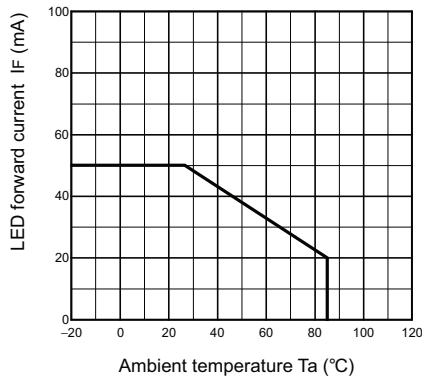

Continuous load current vs. Ambient temperature  
IO - Ta

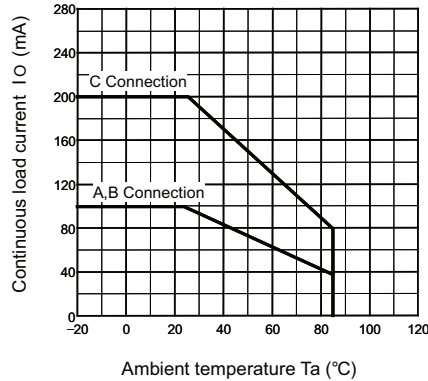

LED forward current vs. LED forward voltage  
IF - VF

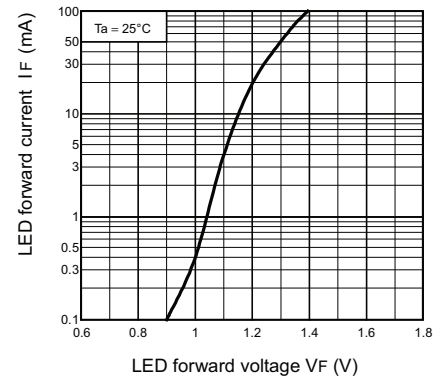

Continuous load current vs. On-state voltage  
IO - VON

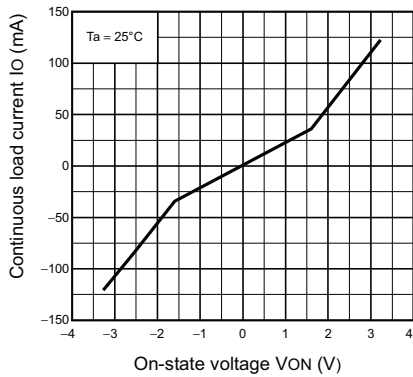

On-state resistance vs. Ambient temperature  
RON - Ta

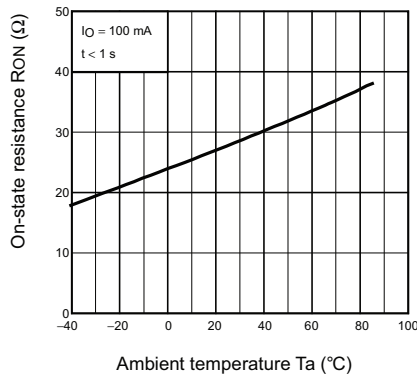

Trigger LED forward current vs. Ambient temperature  
IFC - Ta

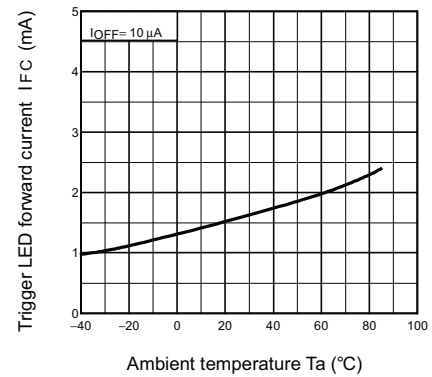

Turn ON, Turn OFF time vs. LED forward current  
tON, tOFF - IF

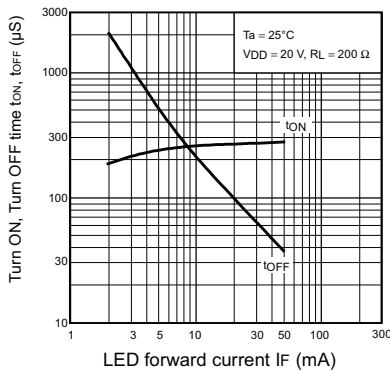

Turn ON, Turn OFF time vs. Ambient temperature  
tON, tOFF - Ta

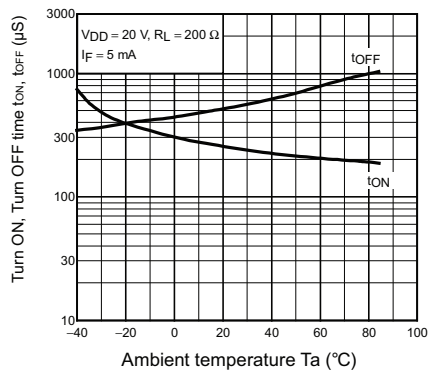

Current leakage vs. Ambient temperature  
ILEAK - Ta

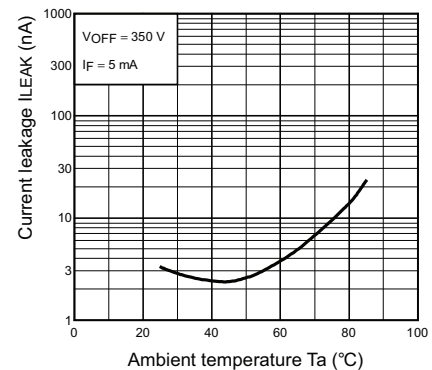



All sales are subject to Omron Electronic Components LLC standard terms and conditions of sale, which can be found at [http://www.components.omron.com/components/web/webfiles.nsf/sales\\_terms.html](http://www.components.omron.com/components/web/webfiles.nsf/sales_terms.html)

**ALL DIMENSIONS SHOWN ARE IN MILLIMETERS.**  
To convert millimeters into inches, multiply by 0.03937. To convert grams into ounces, multiply by 0.03527.

---

**OMRON**<sup>®</sup>

**OMRON ELECTRONIC  
COMPONENTS LLC**

55 E. Commerce Drive, Suite B  
Schaumburg, IL 60173

**847-882-2288**

**OMRON ON-LINE**

Global - <http://www.omron.com>

USA - <http://www.components.omron.com>

Cat. No. X302-E-1

12/10

Specifications subject to change without notice

Printed in USA