

DETAILS

Product Number	FCN13929_BARBARA-WW-PF-VERO13/18
Family	Barbara
Type	RefPack
Color	metal
Diameter	70 mm
Height	41,7 mm
Style	round
Optic Material	
Holder Material	
Fastening	
Status	production ready
ROHS Compliant	Yes
Date Updated	6/03/2017



OPTICAL PROPERTIES

LED	Viewing Angle	Light Beam	Efficiency	cd/lm	Connector
VERO13	51 deg	Very Wide	90 %	1.400	-
VERO18	58 deg	Very Wide	91 %	1.170	-
V15 Gen6	51 deg	Very Wide	86 %	1.390	Bender Wirth: 456 Typ L2
Xenio Point 13mm	49 deg	Very Wide	89 %	1.370	LEDiL: LEDiL
Xenio Point 18mm	59 deg	Very Wide	88 %	1.070	LEDiL: LEDiL
CLU700/701	28 deg	Very Wide	88 %	2.100	Bender Wirth: 434 Typ L1
CLL02x/CLU02x (LES10)	43 deg	Very Wide	88 %	1.600	Bender Wirth: 434 Typ L1
CLL03x/CLU03x	50 deg	Very Wide	86 %	1.300	Bender Wirth: 433 Typ L1
CLU720/721	43 deg	Very Wide	86 %	sim: 1.600	Bender Wirth: 433 Typ L1
CXA/B 1816 & CXA/B 1820 & CXA 1850	46 deg	Very Wide	86 %	1.400	Bender Wirth: 437 Typ L1
CXA/B 15xx	41 deg	Very Wide	87 %	1.700	Bender Wirth: 441 Typ L1
LUXEON CoB 1202/1203	39 deg	Very Wide	88 %	1.700	Bender Wirth: 438 Typ L1
CXM-14	sim: 50	Very Wide	sim: 86 %	sim: 1.300	Bender Wirth: 433 Typ L1
CXM-9	sim: 43	Very Wide	sim: 88 %	sim: 1.600	Bender Wirth: 434 Typ L1
COB L-Type (LES 9)	41 deg	Very Wide	89 %	1.700	Bender Wirth: 438 Typ L1
COB J-Type	51 deg	Very Wide	86 %	1.300	Bender Wirth: 463 Typ L2
COB L-Type (LES 11)	46 deg	Very Wide	87 %	1.500	Bender Wirth: 438 Typ L1
Soleroiq P9	43 deg	Very Wide	90 %	1.700	Bender Wirth: 461 Typ L1
Soleroiq P13	48 deg	Very Wide	88 %	1.400	Bender Wirth: 437 Typ L1
Soleroiq S13	47 deg	Very Wide	87 %	1.400	Bender Wirth: 437 Typ L1
Soleroiq S15	sim: 73	Very Wide	sim: 90 %	sim: 0.770	Bender Wirth: 433 Typ L1
LC026B/LC040B	55 deg	Very Wide	86 %	1.100	Bender Wirth: 450 Typ L2
ZC12/18	sim: 50	Very Wide	sim: 86 %	sim: 1.300	Bender Wirth: 433 Typ L1
ZC4/6	sim: 43	Very Wide	sim: 88 %	sim: 1.600	Bender Wirth: 434 Typ L1
SLE G5 LES11	43 deg	Very Wide	89 %	1.600	Bender Wirth: 434 Typ L1



PRODUCT DATASHEET
Barbara series
last update 6/3/2017

OPTICAL PROPERTIES

LED	Viewing Angle	Light Beam	Effi- ciency	cd/lm	Connector
-----	------------------	---------------	-----------------	-------	-----------

Relative intensity of FCN13929_BARBARA-WW-PF-VERO13_18_(V15)

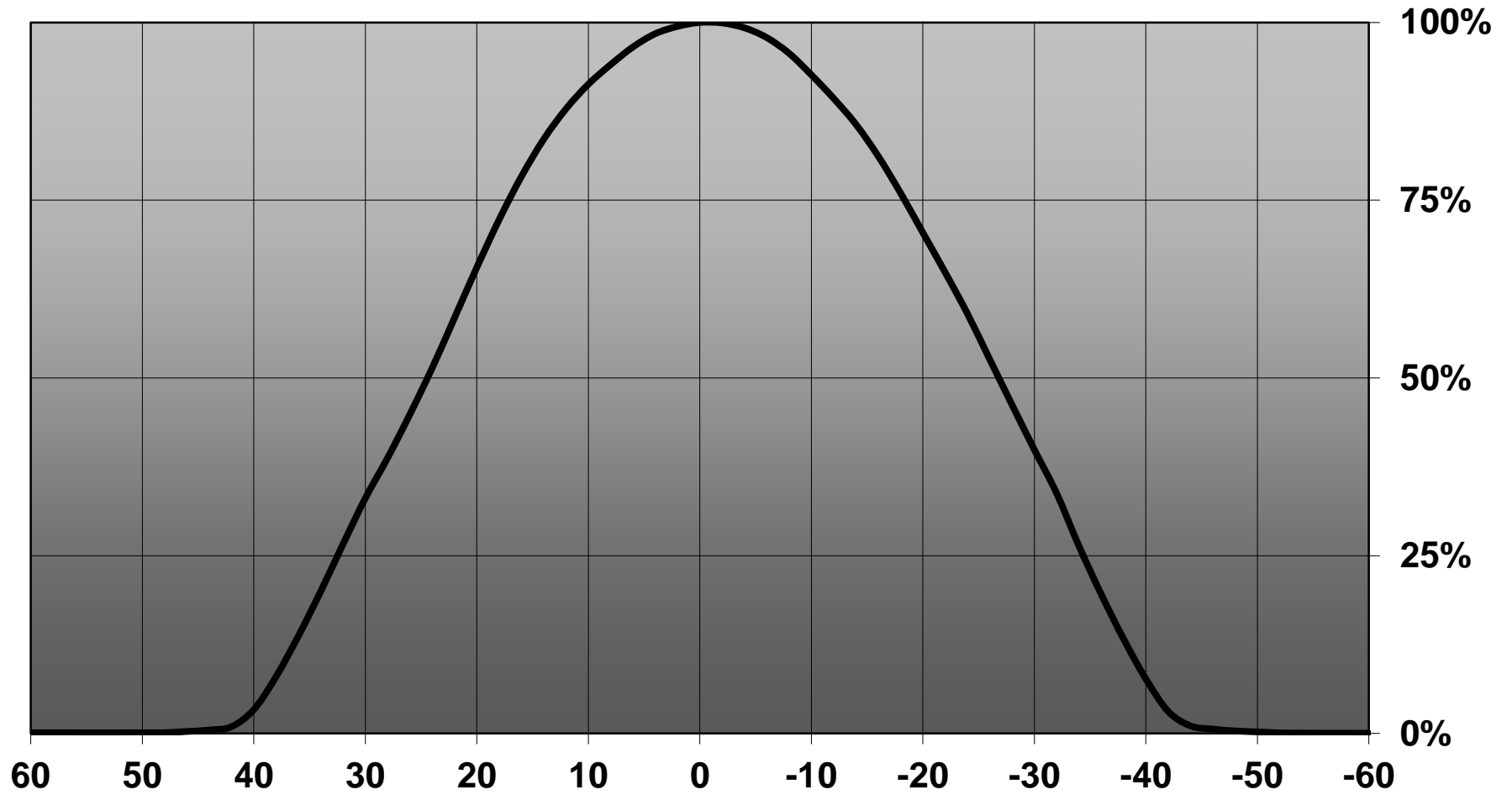

H G F E D C B A

4

3

2

1

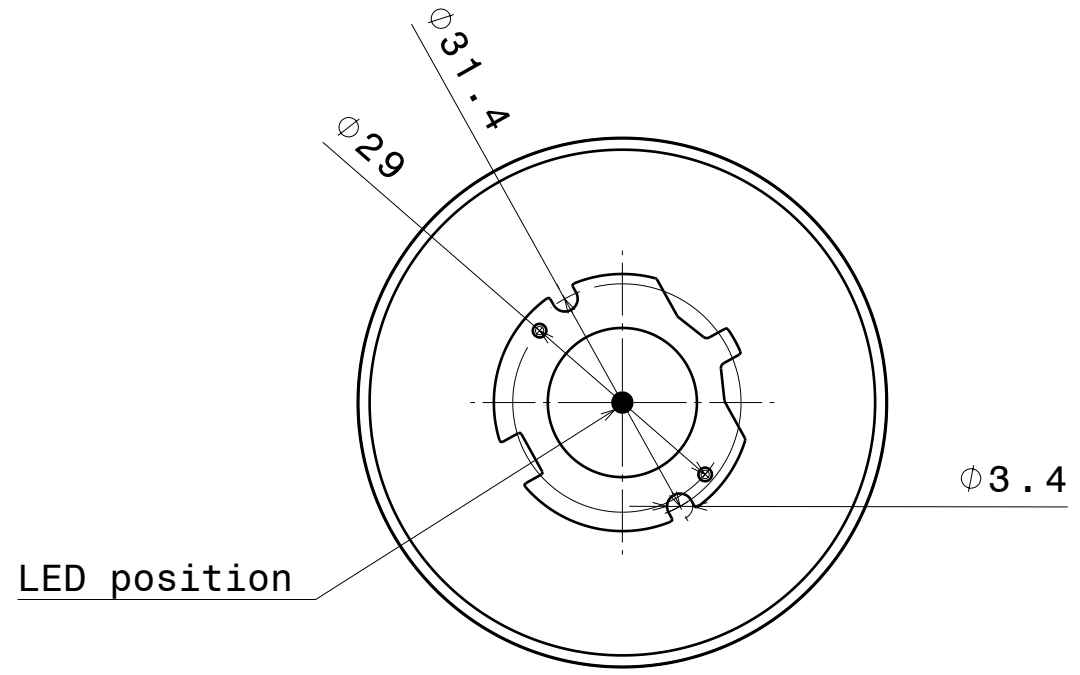
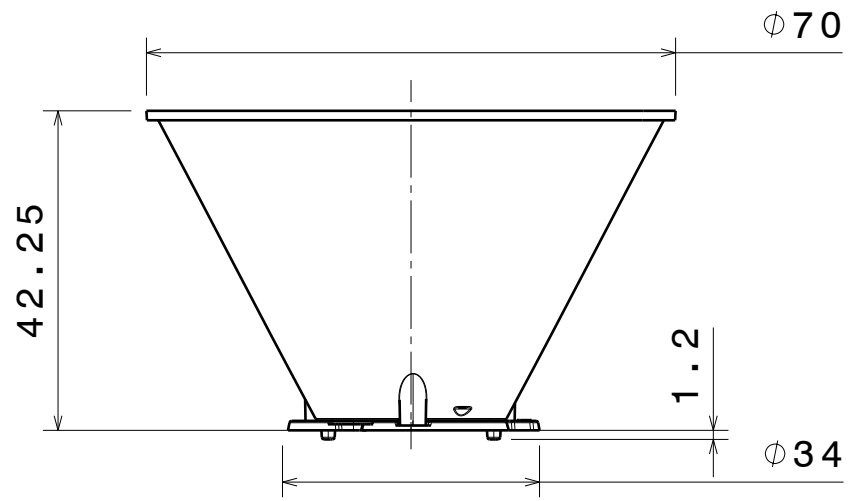

LED position

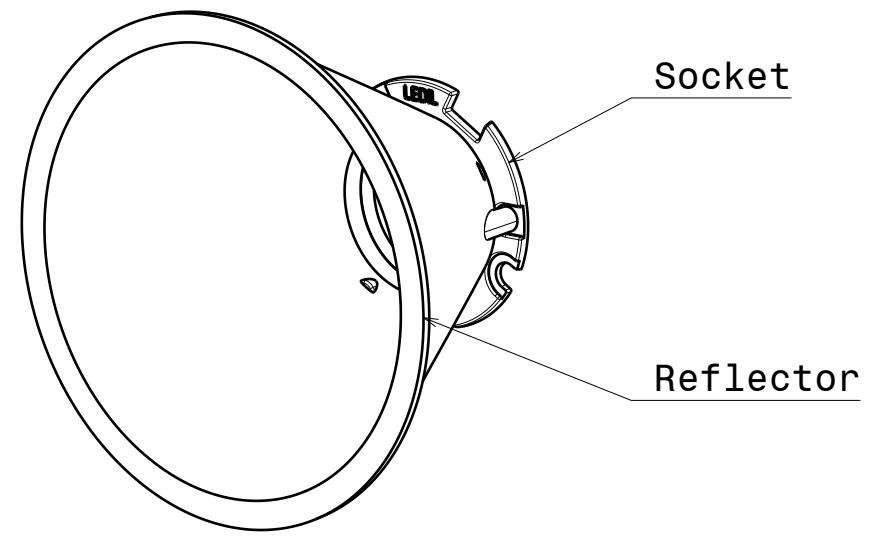

INDEX	PART NO	MATERIAL	COLOUR
1	Socket	PC	White
2	Reflector	PC	Metal

Tolerances if not otherwise shown
 According to DIN ISO 2768-1
 Linear measures: class C
 According to DIN ISO 2768-2
 Form and position: class L

LEDiL LediL Oy
 Salorankatu 10
 FIN 24240 SALO
 Finland

THIRD ANGLE PROJECTION:

DRAWING TITLE **DATA SHEET BARBARA-PF SOCKET-VERO13-18**

This drawing is the property of LEDiL Oy. It may not be reproduced, copied or communicated without a written agreement with LEDiL Oy.

SIZE **A3** PART NUMBER -

SCALE 1:1 WEIGHT - SHEET 1/1

H G B A

Luminaire: LEDil Oy FCN13929_BARBARA-WW-PF-VERO1318_(VERO13) Efficiency=90%
Lamps: 1 x Bridgelux (BXRC-40E2000C) 1025lm @ 250mA CCT=4000K P=7.7W I=250mA

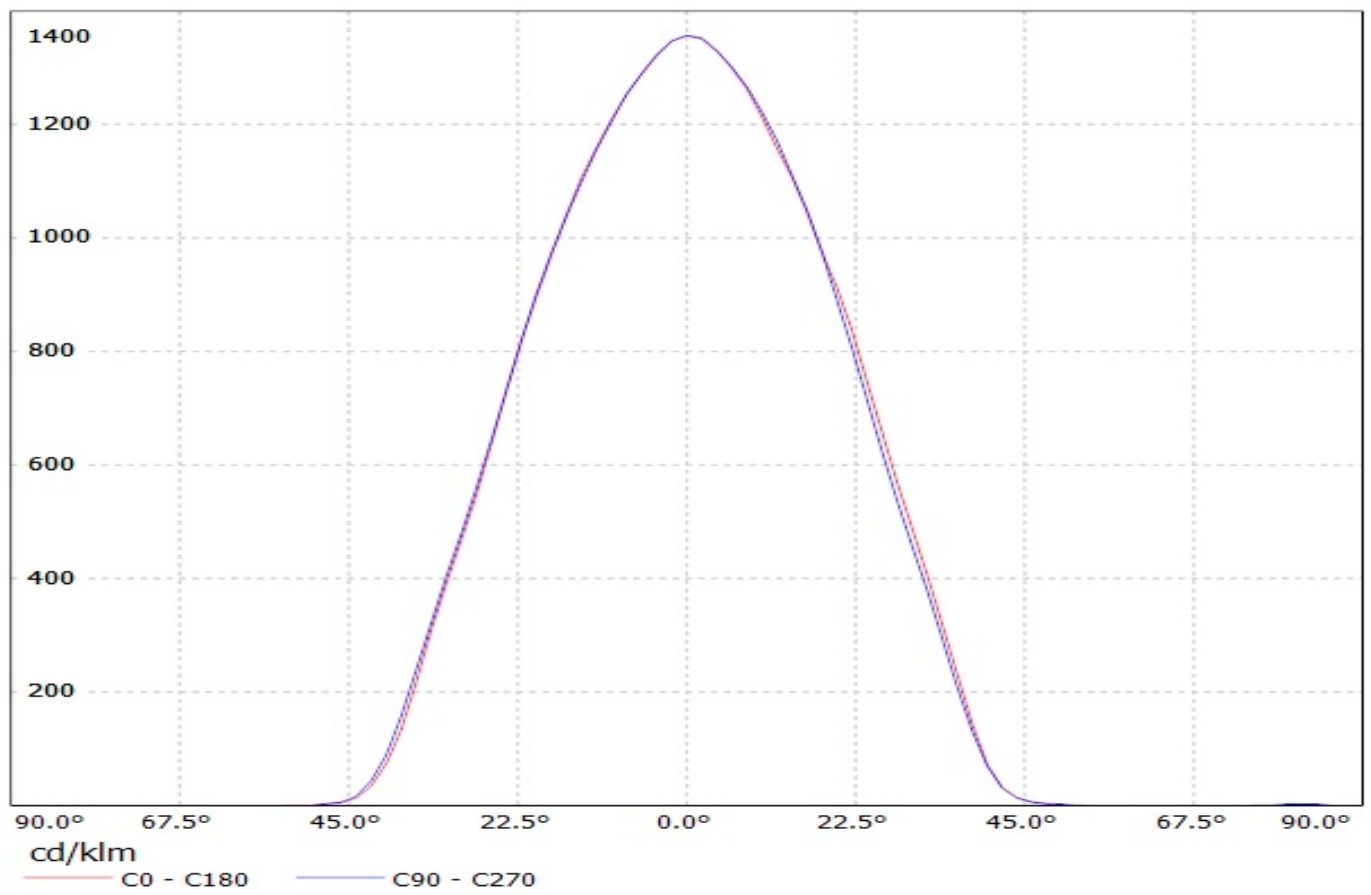

Luminaire: LEDil Oy FCN13929_BARBARA-WW-PF-VERO1318_(VERO18)

Lamps: 1 x Bridgelux VERO18 (BXRC-30E4000F) 865lm @ 250mA CCT=3200K P=6.9W I=250mA

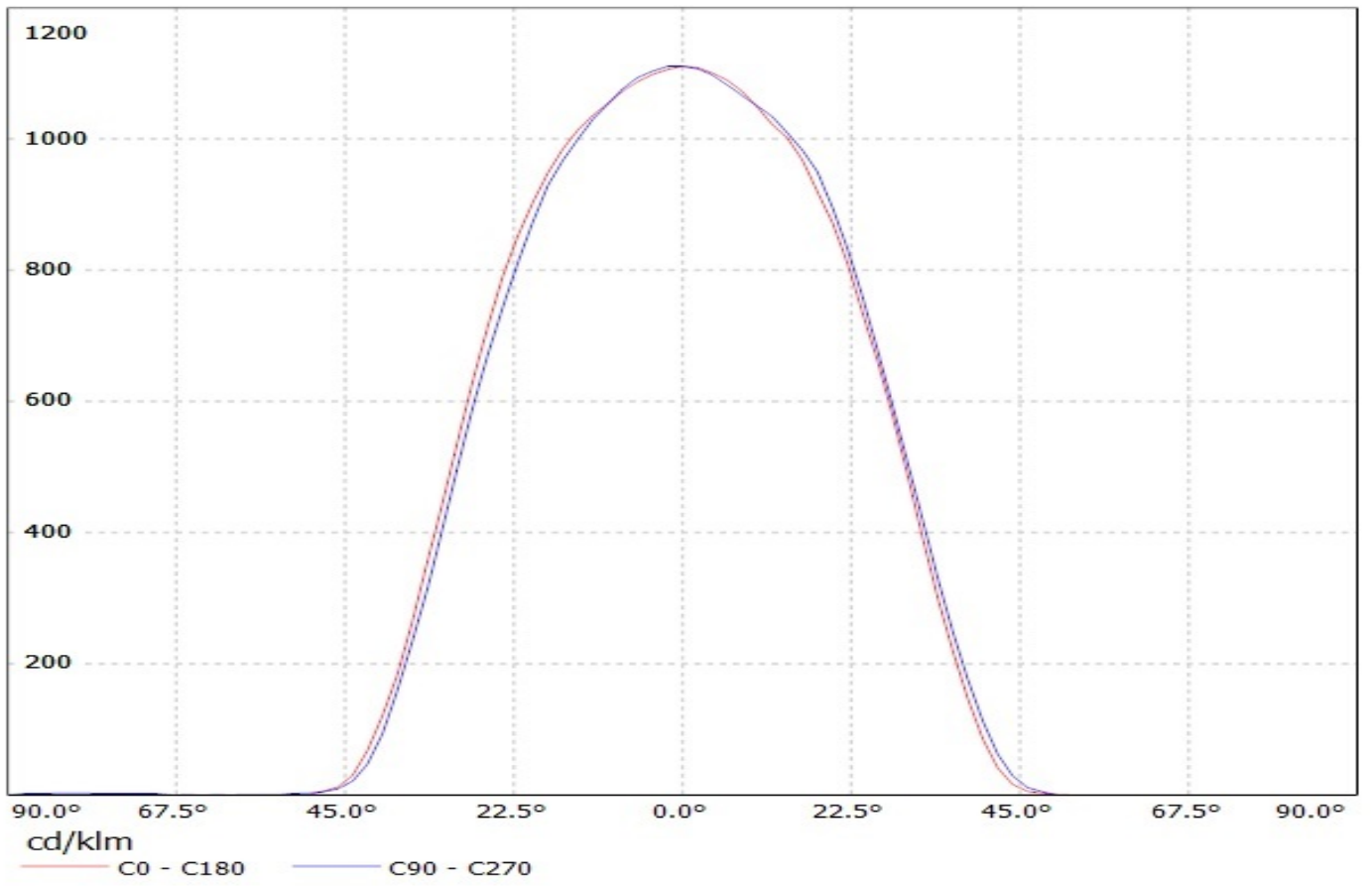

Luminaire: LEDiL Oy FCN13929_BARBARA-WW-PF-VERO13/18_(XENIO_13MM)
Lamps: 1 x XENIO_13MM_2074.66lm@?mA_P=23W_I=?A

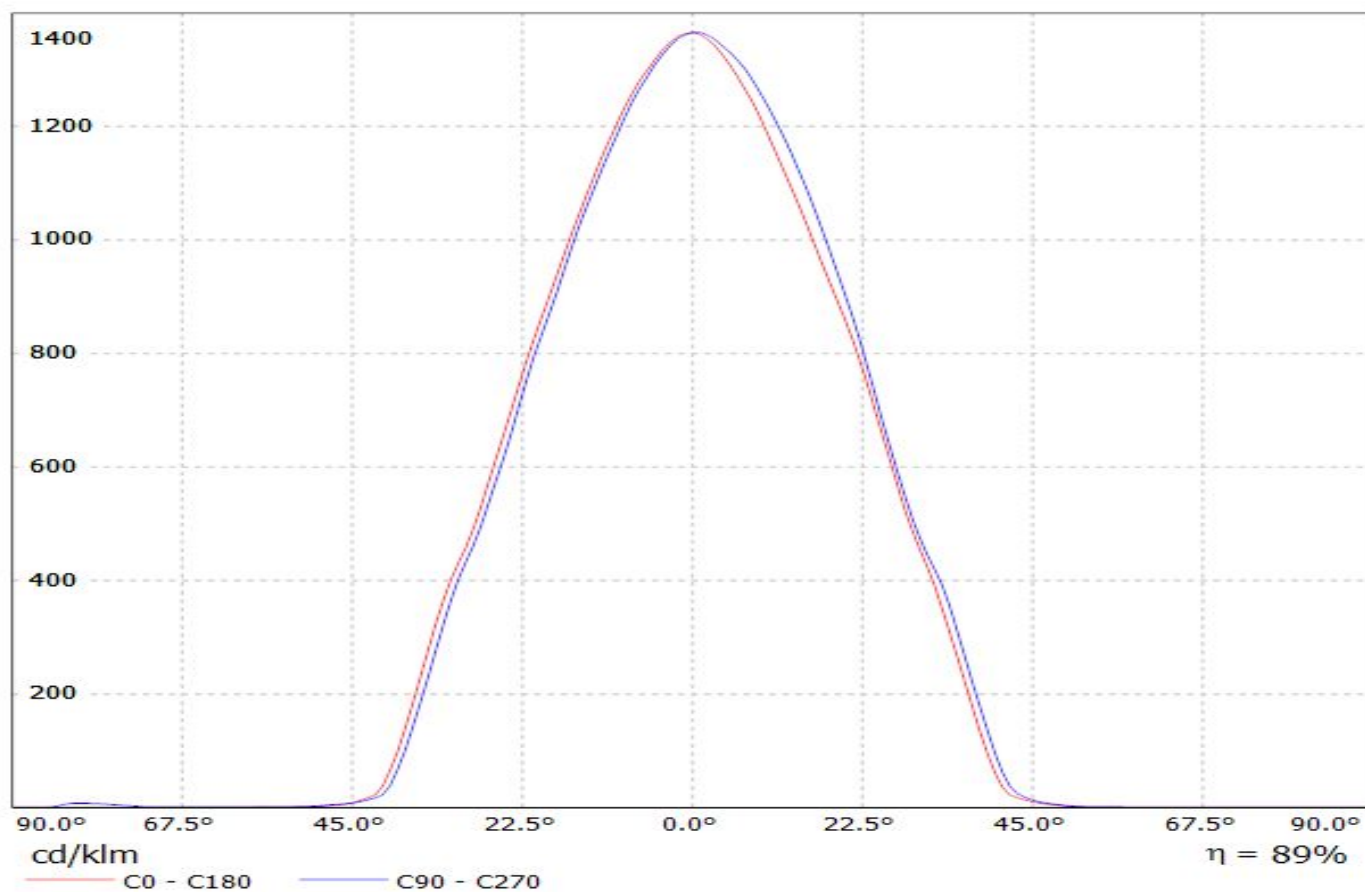

Luminaire: LEDiL Oy FCN13929_BARBARA-WW-PF-VERO13/18_(Xenio_18mm)
Lamps: 1 x Xenio_18mm_3756.62lm@?mA_P=43W_I=?A

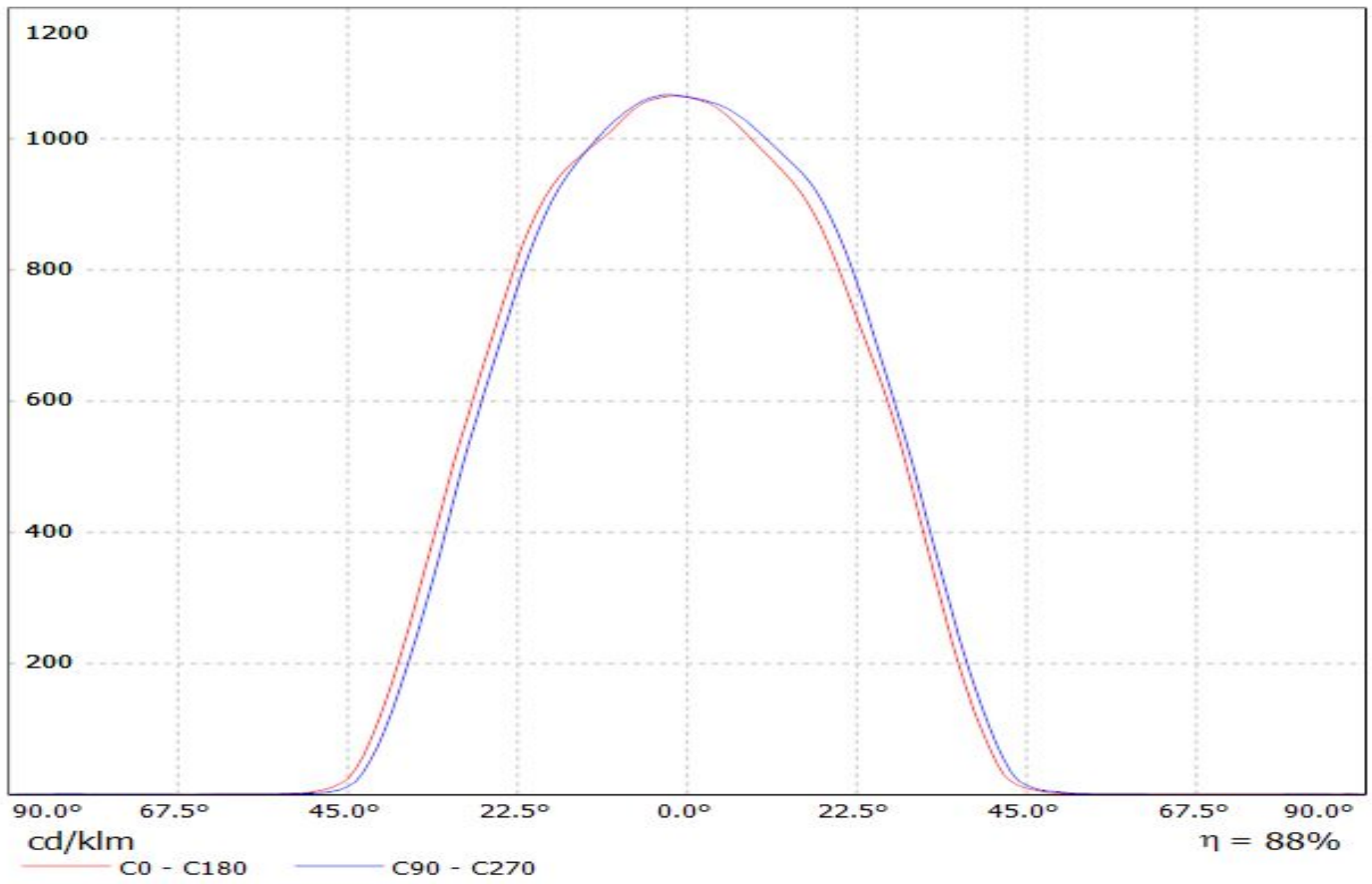

Luminaire: LEDiL Oy FCN13929_BARBARA-WW-PF-VERO13-18_(CLU700)

Lamps: 1 x Citizen_CLU700_(CLU700-1002B8-273M2G1)_(C13709)_(434_Typ_L1)_374.62lm@100mA_P=2.81352W_I=0.1002A

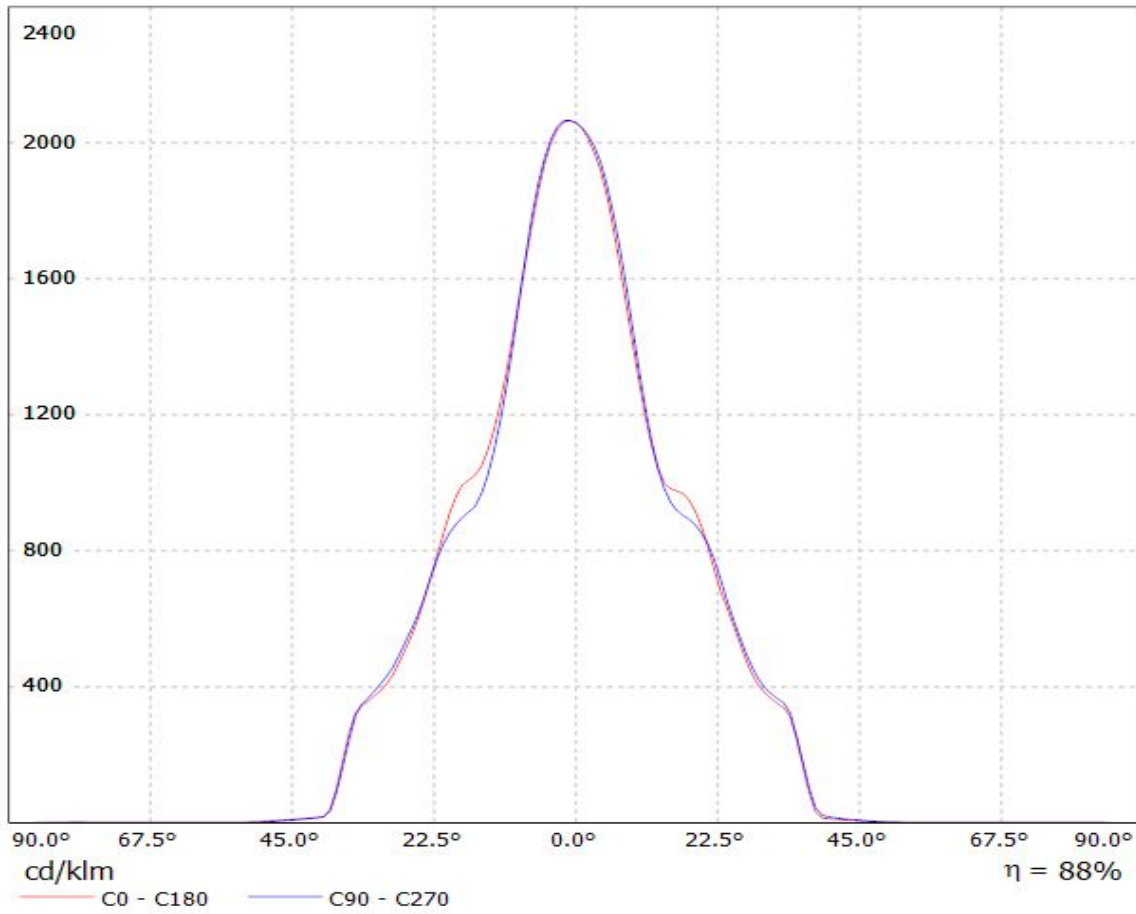

Luminaire: Ledil FCN13929_BARBARA-WW-PF-VERO13/18_(CLU024) Citizen_CLU024_(434_Typ_L1)_
(C13709_Pf-SOCKET-VERO13-18)_1065.5lm@250mA_P=8.55W_I=0.25A
Lamps: 1 x Citizen_CLU024_(434_Typ_L1)_ (C13709_Pf-SOCKET-VERO13-18)
_1065.5lm@250mA_P=8.55W_I=0.25A

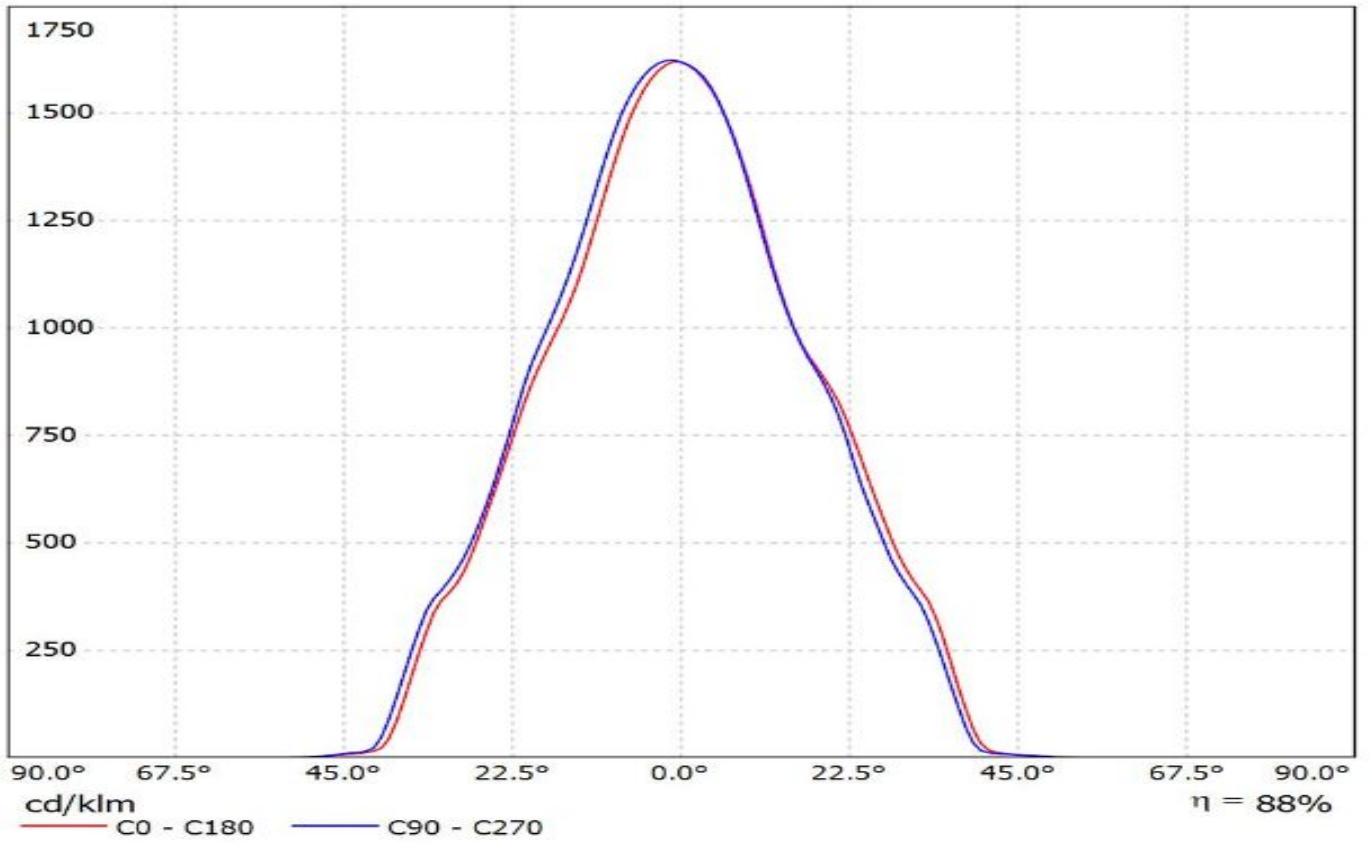

Ledil FCN13929_BARBARA-WW-PF-VERO13-18_(CLU034)_(433_Typ_L1) / LDC (Linear)

Luminaire: Ledil FCN13929_BARBARA-WW-PF-VERO13-18_(CLU034)_(433_Typ_L1)

Lamps: 1 x Citizen_CLU034_(CLU034-1205B8-303M1A2)_1180.79lm@250mA_P=8.50075W_I=0.25A

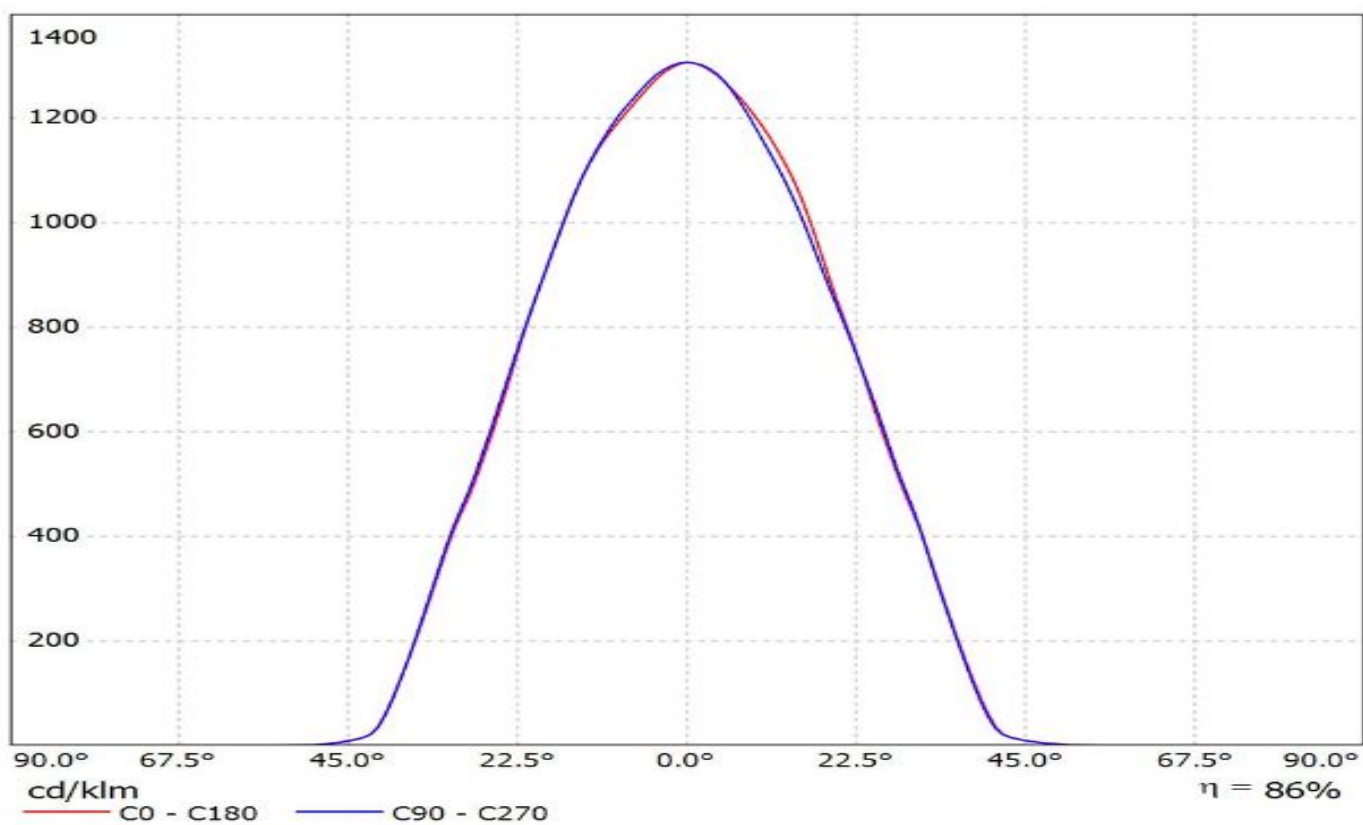

Ledil FCN13929_BARBARA-WW-PF-VERO13-18_(CLU720)_(433_Typ_L1) / LDC
(Linear)

Luminaire: Ledil FCN13929_BARBARA-WW-PF-VERO13-18_(CLU720)_(433_Typ_L1)
Lamps: 1 x Citizen_CLU720_(433_Typ_L1)_(C13709_PF-SOCKET-VERO13-18)
_1233.06lm@250mA_P=8.3W_I=0.25A

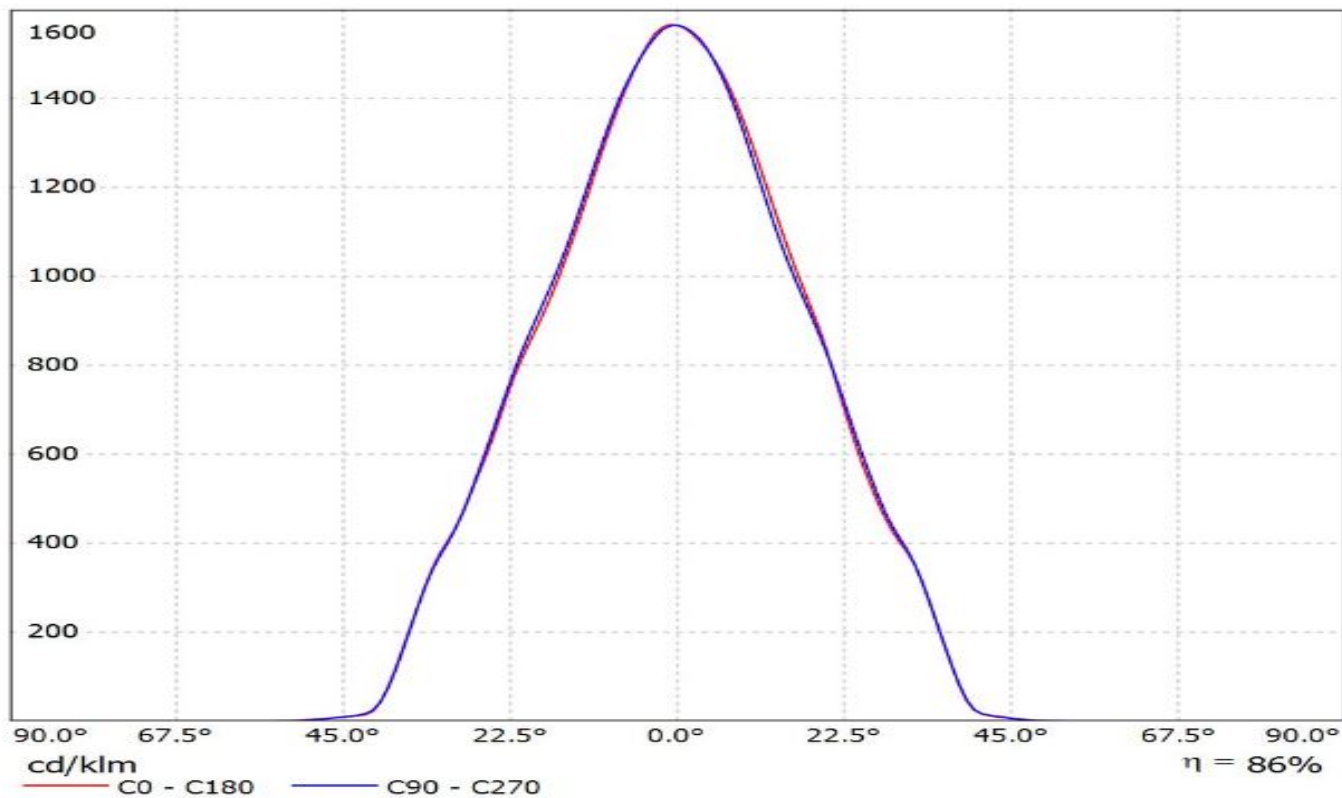

Ledil FCN13929_BARBARA-WW-PF-VERO13-18_(CXA1850) / LDC (Linear)

Luminaire: Ledil FCN13929_BARBARA-WW-PF-VERO13-18_(CXA1850)

Lamps: 1 x CREE_CXA1850_(CXA1850-30F-T4-N0Y-00001)

_847.836lm@250mA_CCT=3000K_P=8.27W_I=0.25A

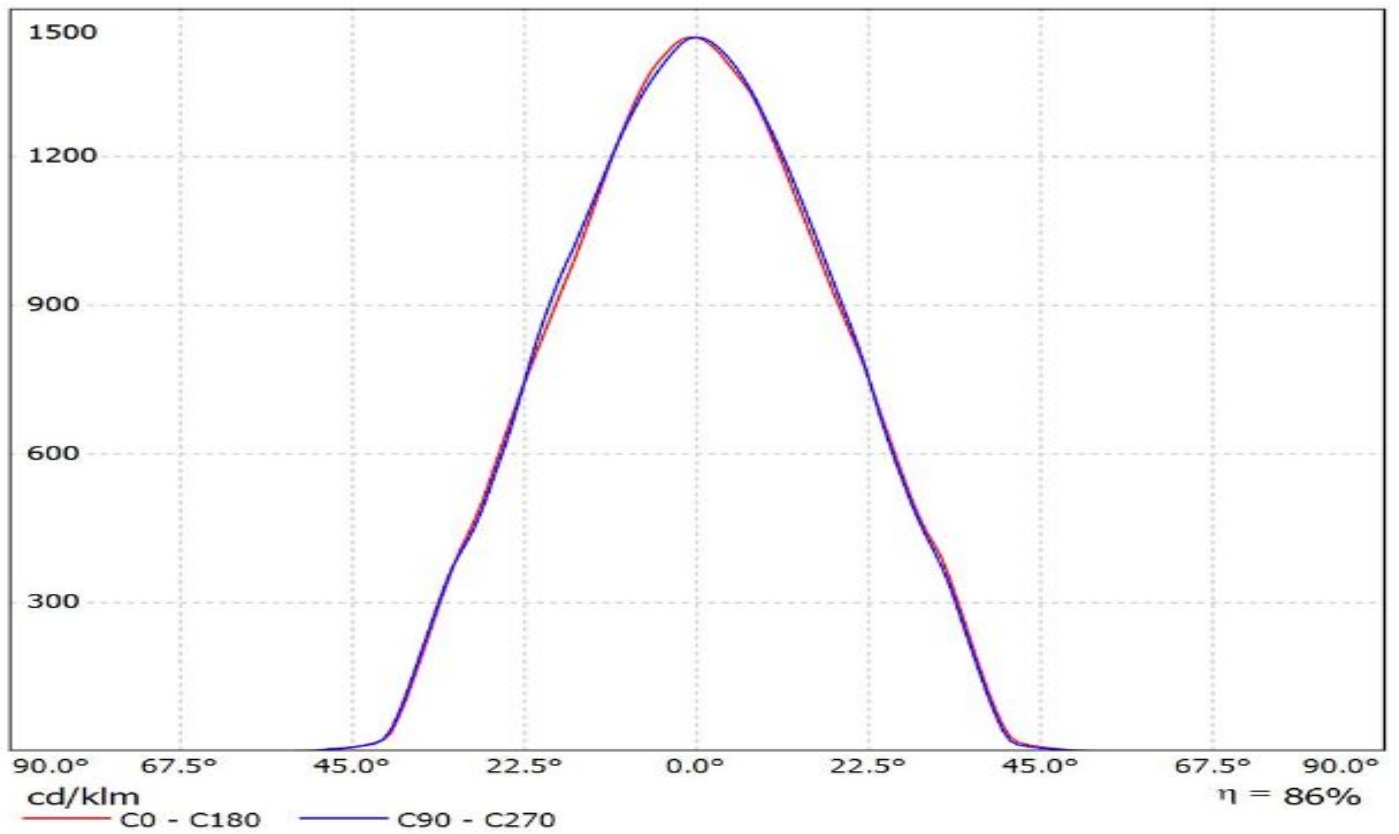

Luminaire: Ledil FCN13929_BARBARA-WW-PF-VERO13-18_(CXA1520) CXA1520_(CXA1520-30F-N4-N0H-00001)_(441_Typ_L1)_(C13709_PF-SOCKET-VERO13-18)_1036.14lm@250mA_P=8.825W_I=0.25A
Lamps: 1 x CXA1520_(CXA1520-30F-N4-N0H-00001)_(441_Typ_L1)_(C13709_PF-SOCKET-VERO13-18)_1036.14lm@250mA_P=8.825W_I=0.25A

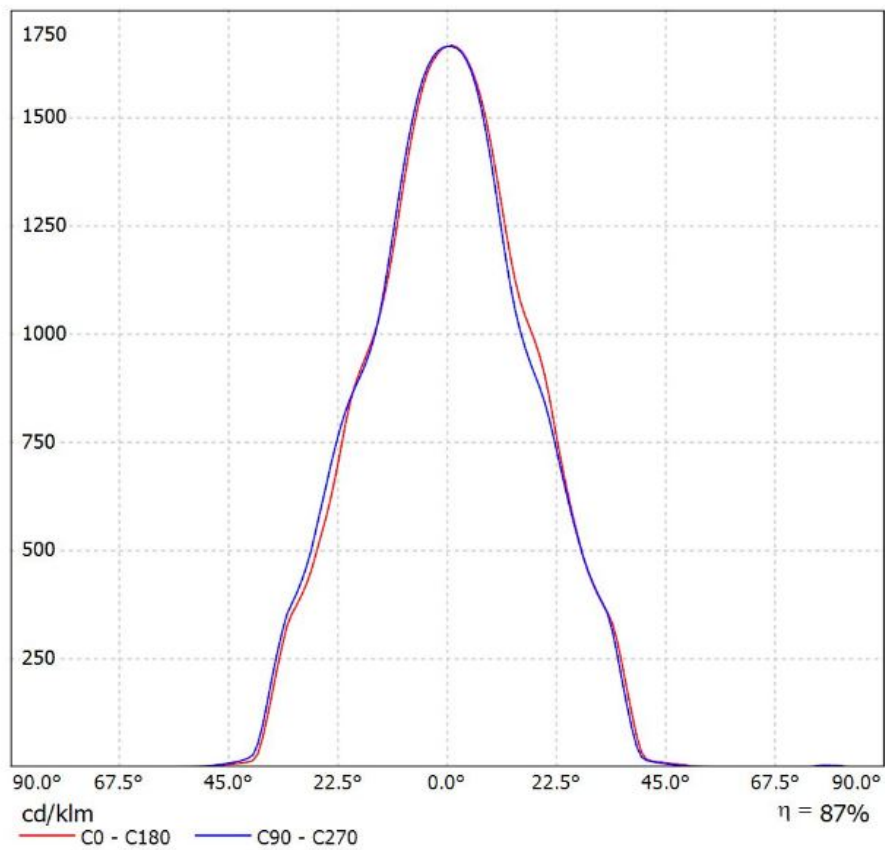

Luminaire: LEDiL Oy FCN13929_BARBARA-WW-PF-VERO13-18_(Luxeon CoB 1203)

Lamps: 1 x Luxeon_COB_1203_(LHC1-3080-1203)_(C13868_LENA-STD-BASE-VERO13-18)_(438_Typ_L1)_990.381lm@250mA_P=8.6818W_I=0.2498A

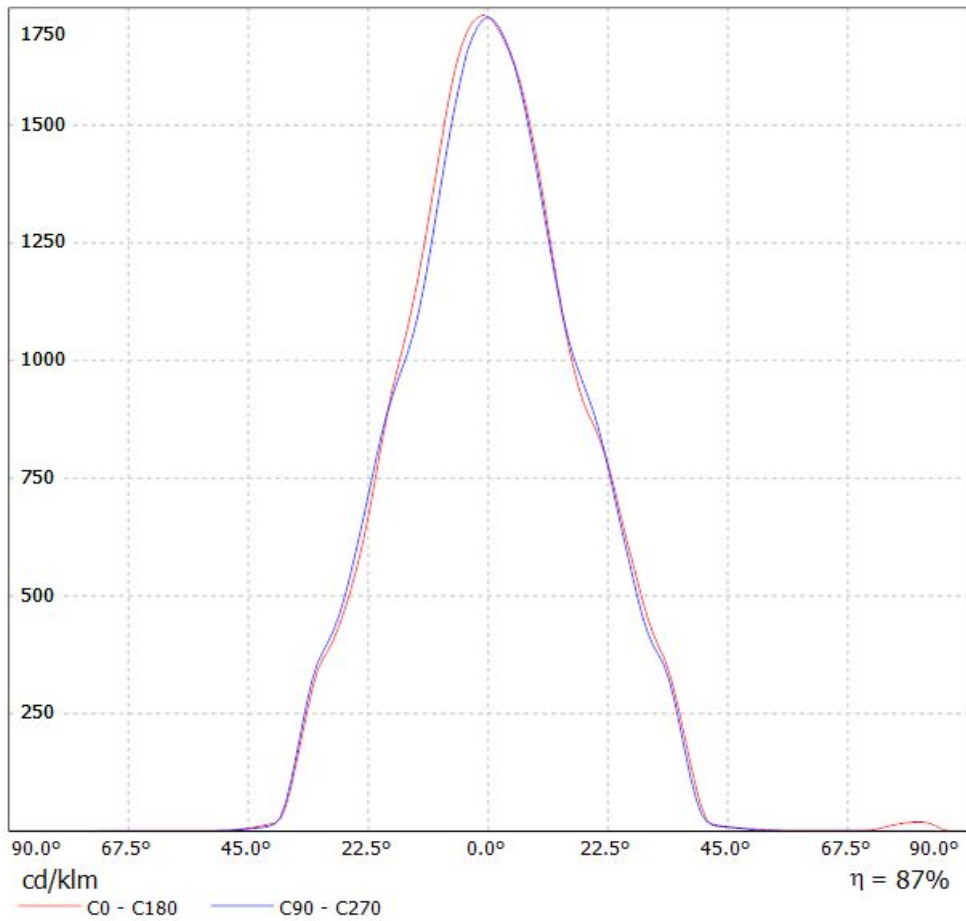

Luminaire: LEDiL Oy FCN13929_BARBARA-WW-PF-VERO13-18_(NFCLL036B)

Lamps: 1 x Nichia NFCLL036B (sm403J1300R8000)_542.652lm@100mA_CCT=4000K_P=3.34084W_I=0.100A

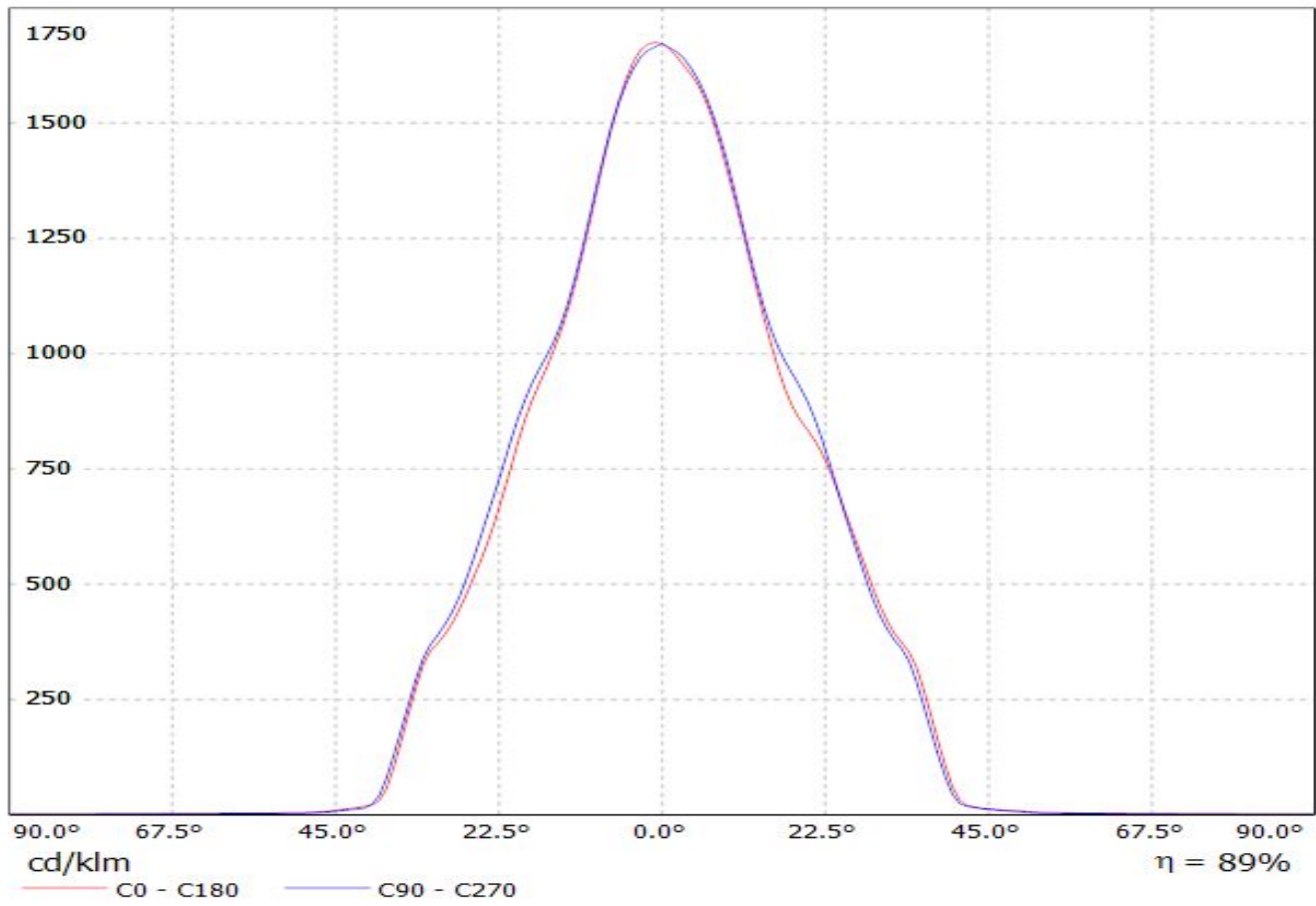

Luminaire: Ledil FCN13929_BARBARA-WW-PF-VERO13/18_(NFDxJ130B)
Lamps: 1 x Nichia_NFDxJ130B_(463 Typ L2)_C13709_PF-SOCKET-VERO13-18_1532.05lm@250mA_P=8.27W_I=0.25A

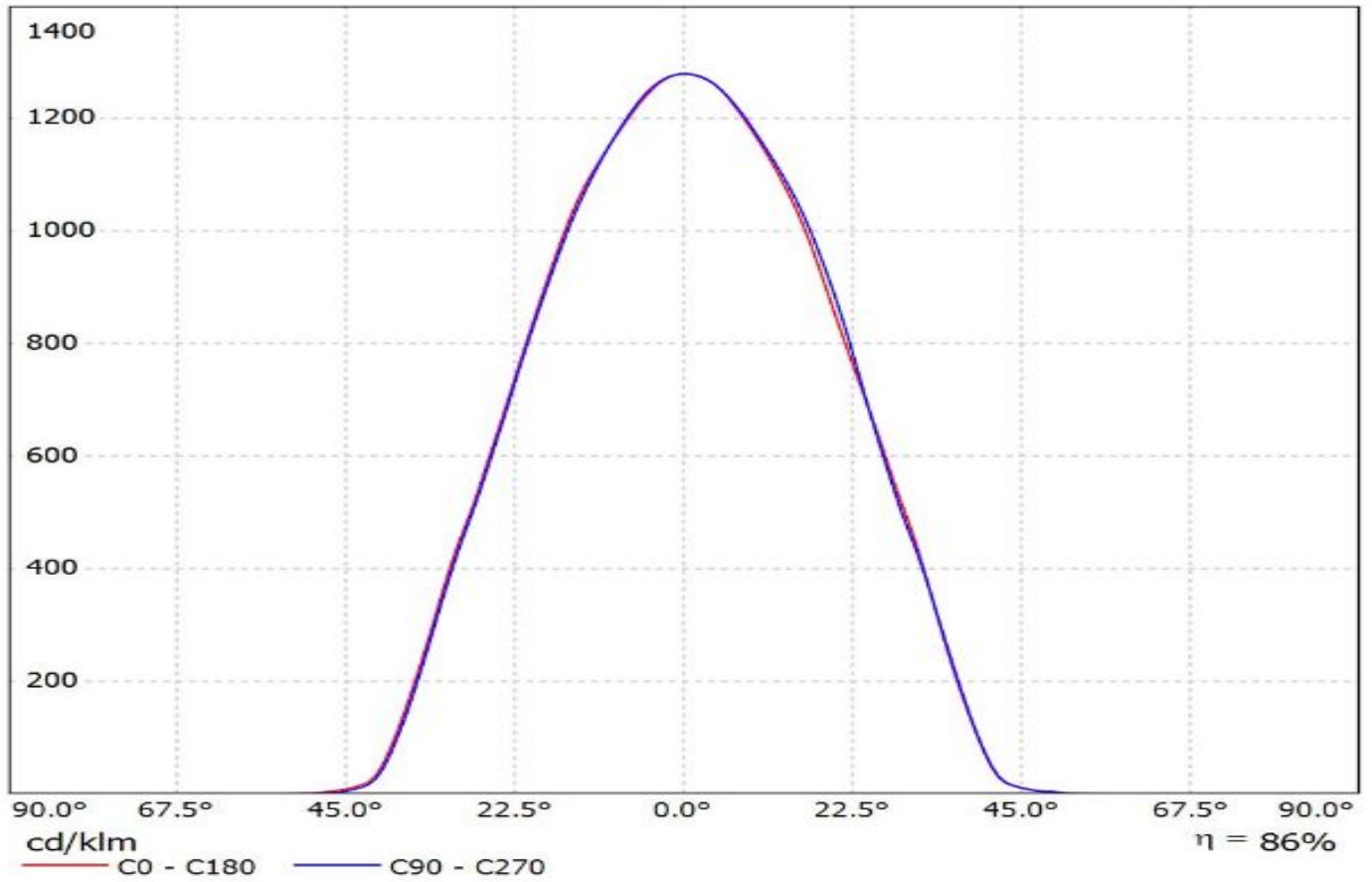

Luminaire: Ledil FCN13929_BARBARA-WW-PF-VERO13/18_(NFCLL060B)
Lamps: 1 x Nichia_NFCLL060B_(438_TYP_L1)_1365.88lm@250mA_P=8.375W_I=0.25A

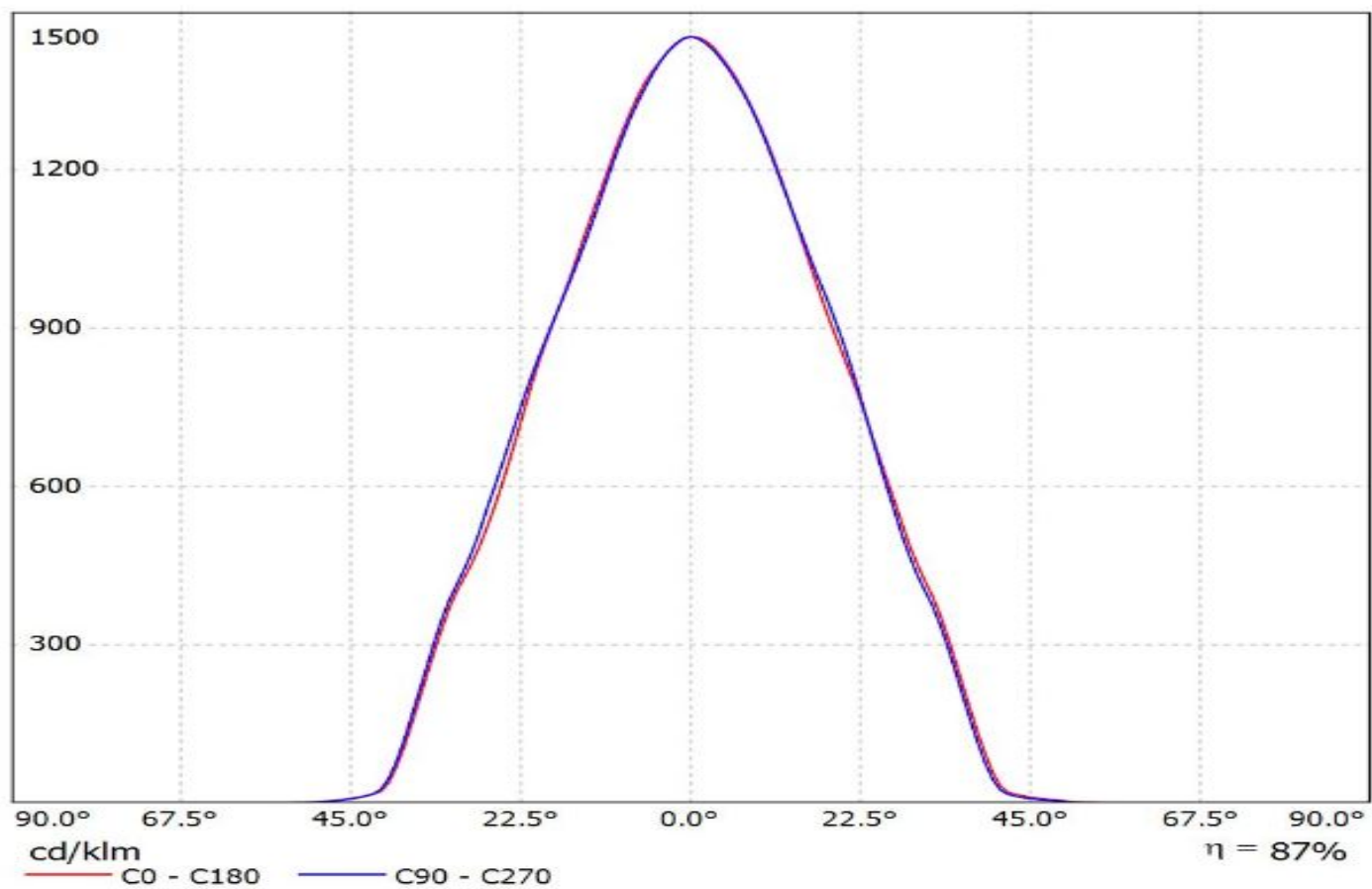

Luminaire: LEDiL Oy FCN13929_BARBARA-WW-PF-VERO13/18_(Soleriq_P9)_Bender+Wirth_connector_461
Lamps: 1 x Osram_Soleriq_P9_(GQ_MAFJB1.EM)_875.631lm@250mA_P=6.94894W_I=0.2498A

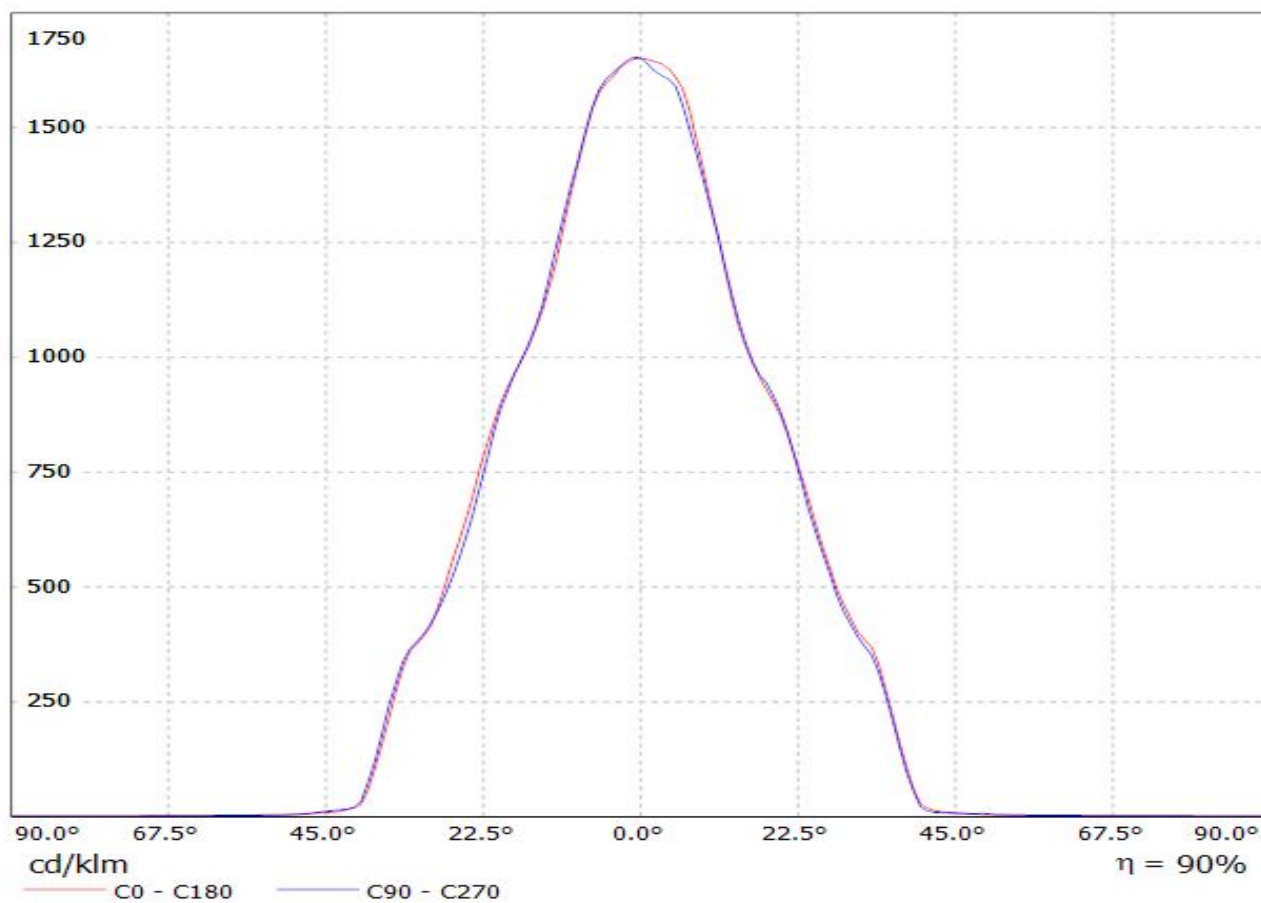

Luminaire: LEDiL Oy FCN13929_BARBARA-WW-PF-VERO13/18_(Soleriq P13)

Lamps: 1 x Osram Soleriq P13 (GW MAGMB1.EM)_921.649lm@250mA_CCT=3500K_P=8.8097W_I=0.25A

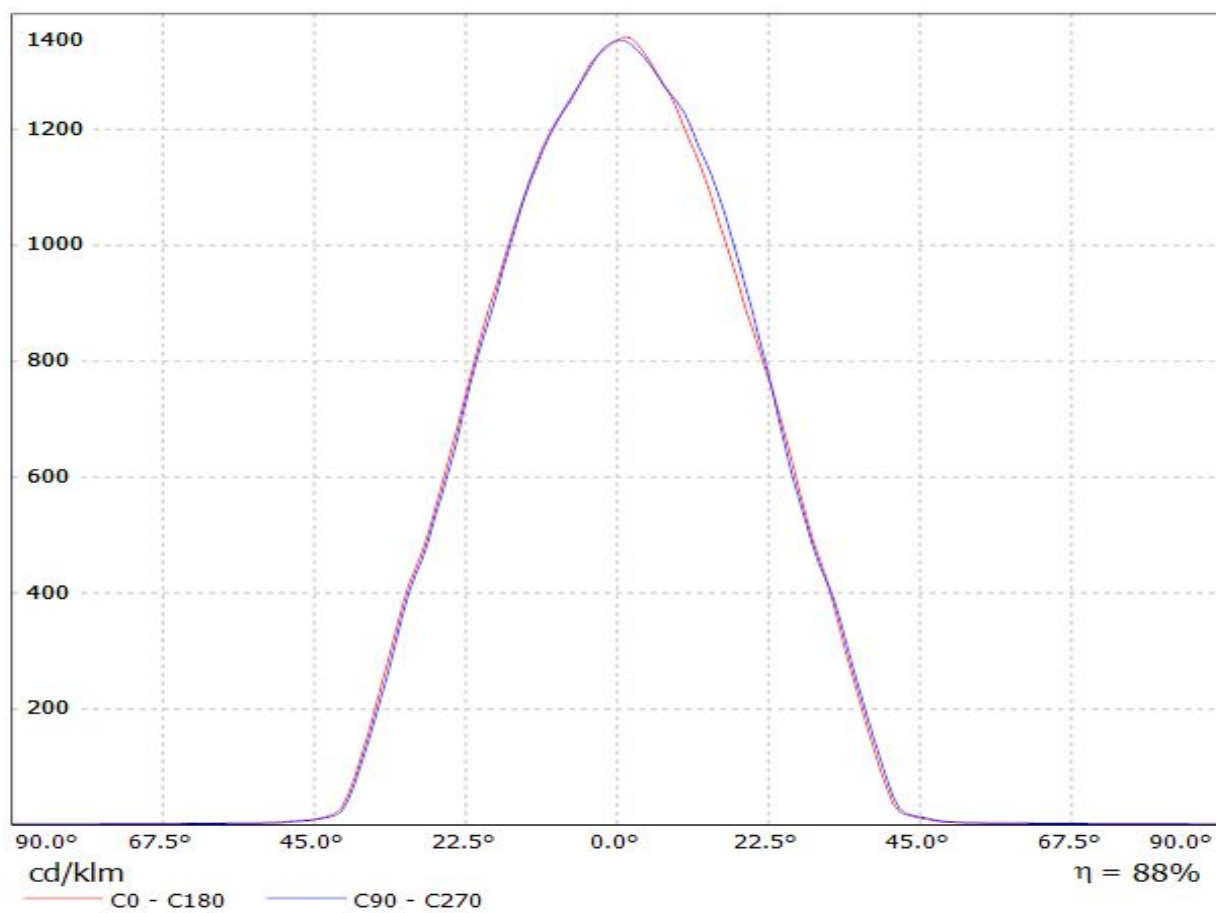

Luminaire: Ledil FCN13929_BARBARA-WW-PF-VERO13-18_(Soleriq_S13)
Lamps: 1 x Osram_Soleriq_S13_(GW_KAGHB1.EM)_931.029lm@250mA_P=7.44679W_I=250mA

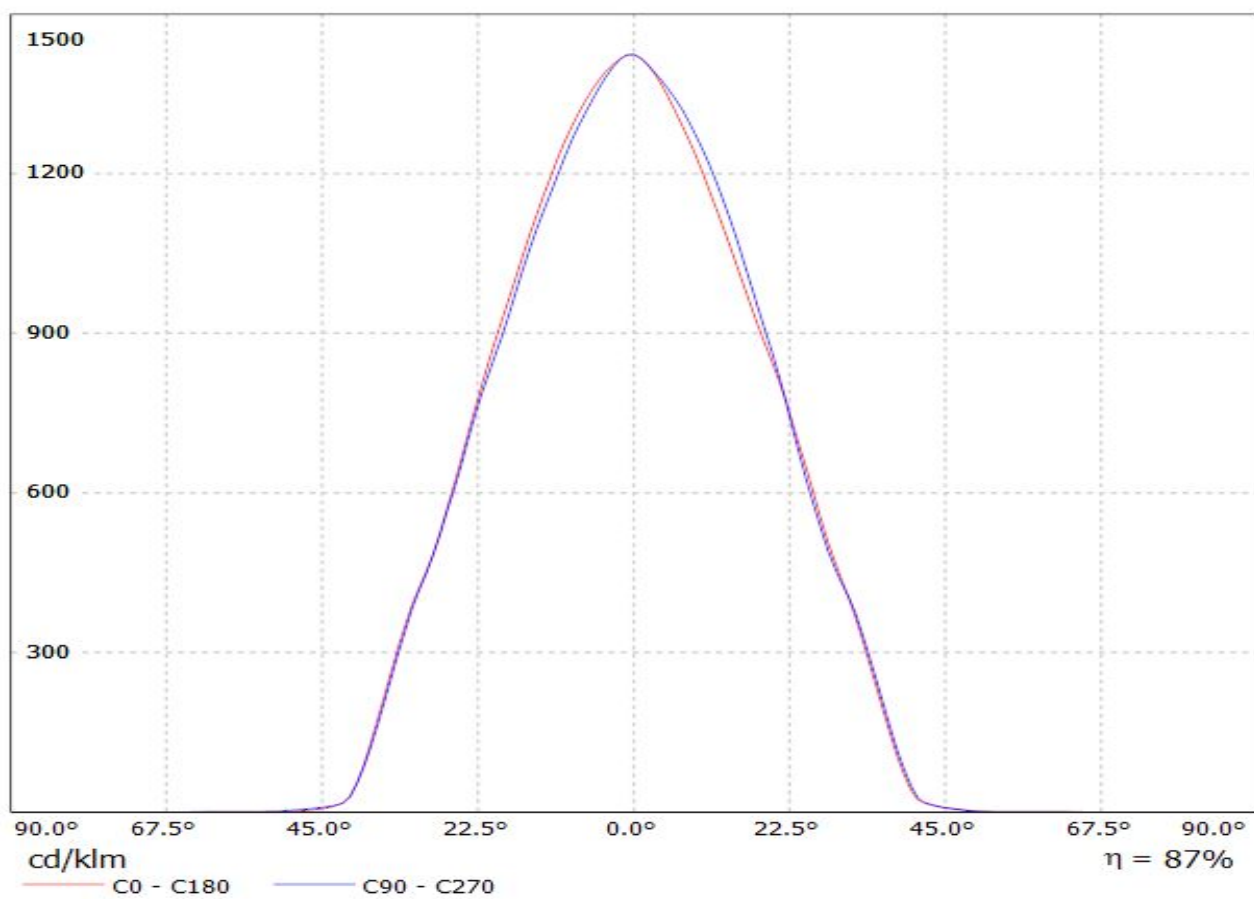

Luminaire: Ledil FCN13929_BARBARA-WW-PF-VERO13/18_(LC040B)_(450_Typ_L2)_(C13709)
Lamps: 1 x Samsung_LC040B_(SPHWW1HDNE25010101)_CCT=3000k_(450_Typ_L2)_(C13709_PF-SOCKET-VERO13-18)_1115.79lm@250mA_P=8.075W_I=0.25A

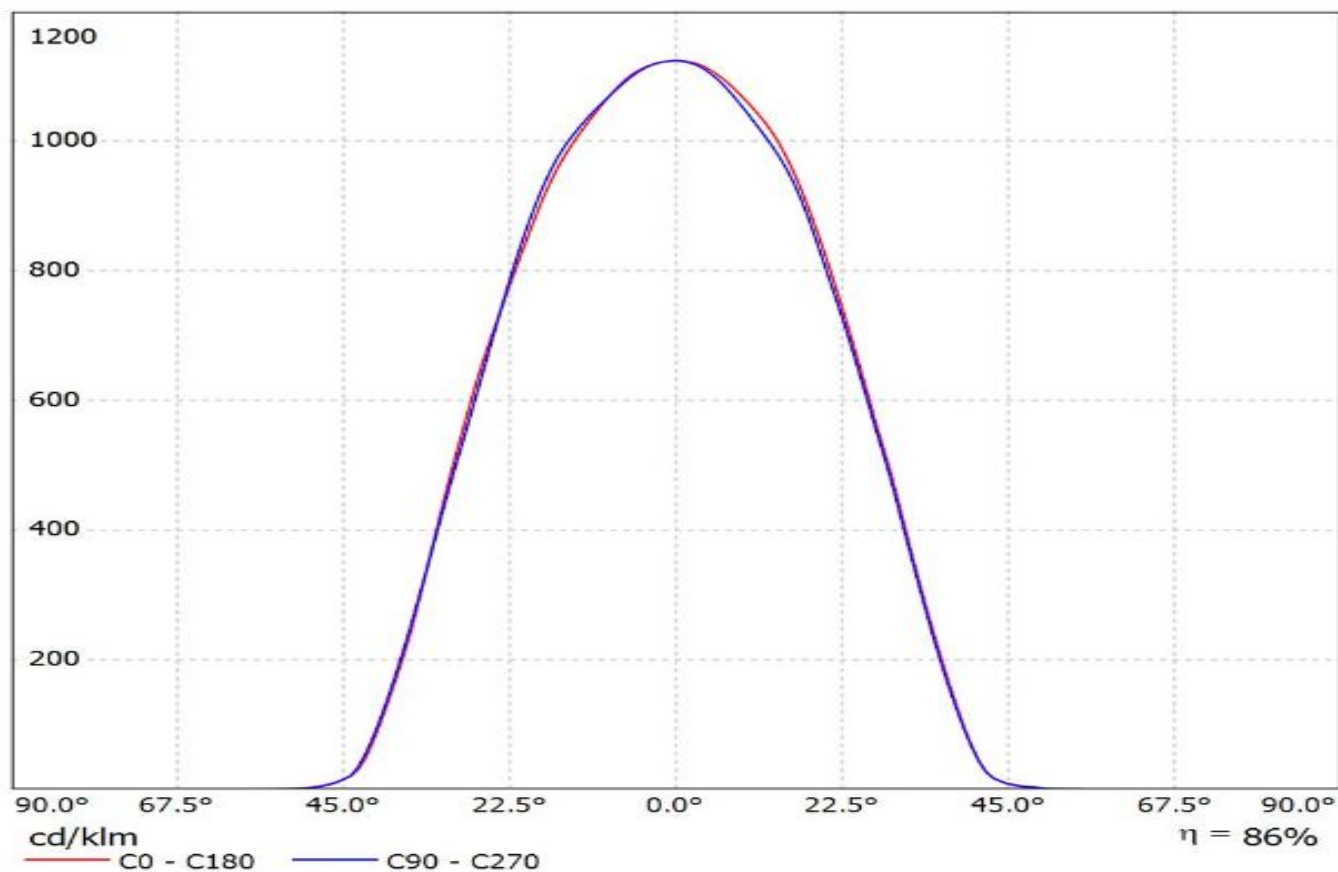

Luminaire: LEDiL Oy FCN13929_BARBARA-WW-PF-VERO13/18_(SLE-G5_LES-11)
Lamps: 1 x Tridonic_SLE-G5_LES-11_1142.55lm@250mA_P=8.4070W_I=0.250A

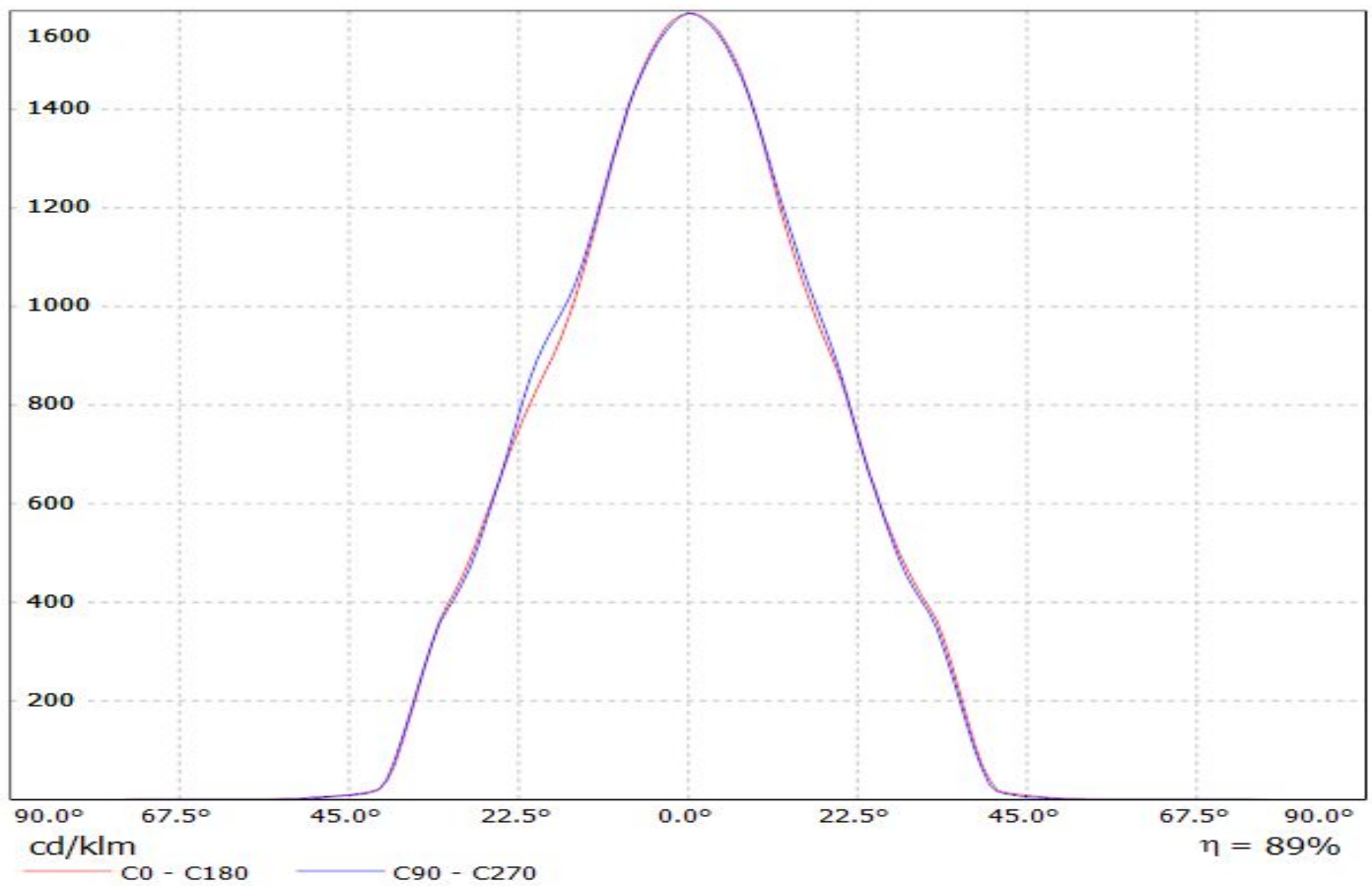

Luminaire: LEDil Oy FCN13929_BARBARA-WW-PF-VERO1318_(VERO13) Efficiency=90%
Lamps: 1 x Bridgelux (BXRC-40E2000C) 1025lm @ 250mA CCT=4000K P=7.7W I=250mA

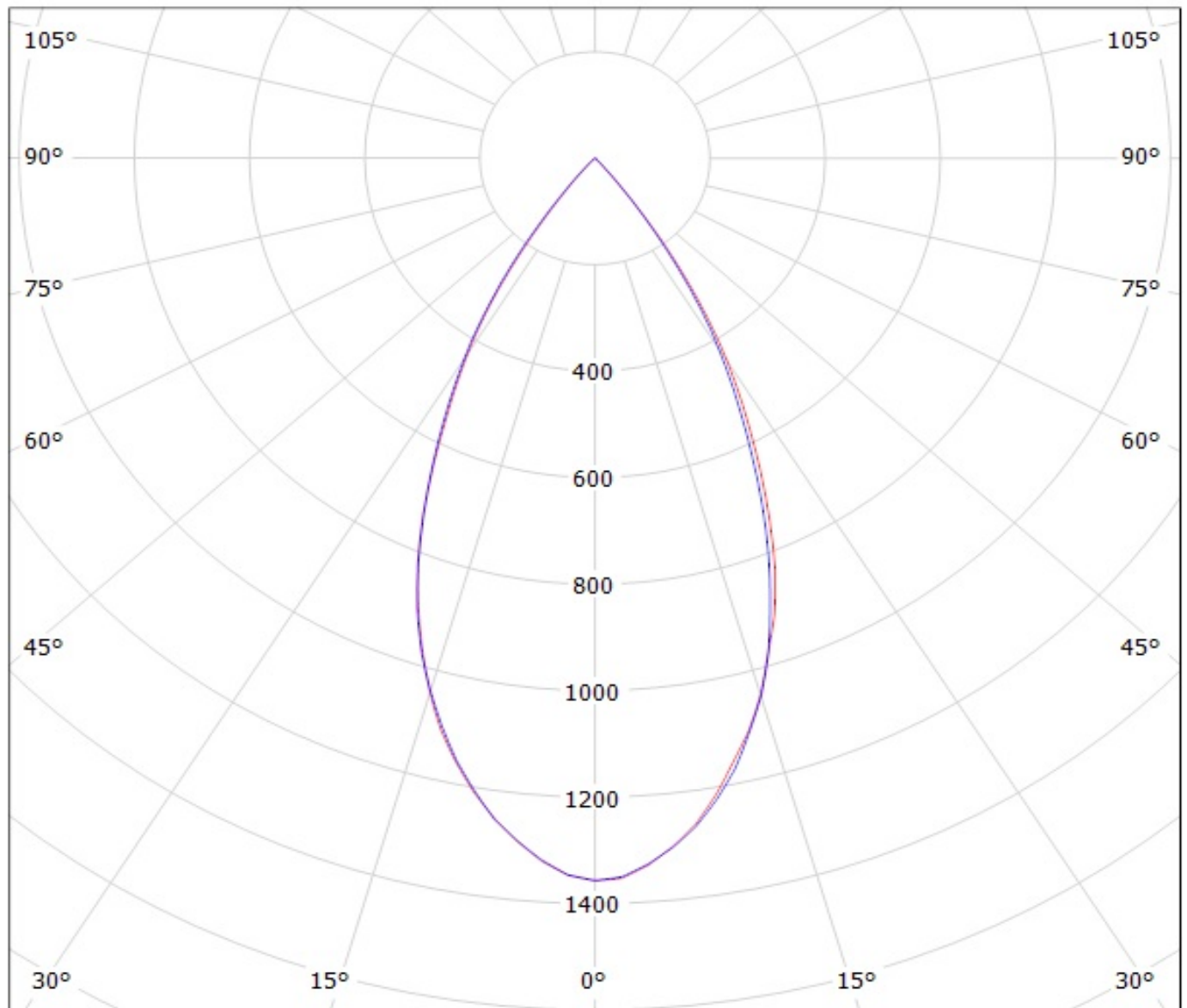

cd/klm

— C0 - C180

— C90 - C270

Luminaire: LEDil Oy FCN13929_BARBARA-WW-PF-VERO1318_(VERO18)

Lamps: 1 x Bridgelux VERO18 (BXRC-30E4000F) 865lm @ 250mA CCT=3200K P=6.9W I=250mA

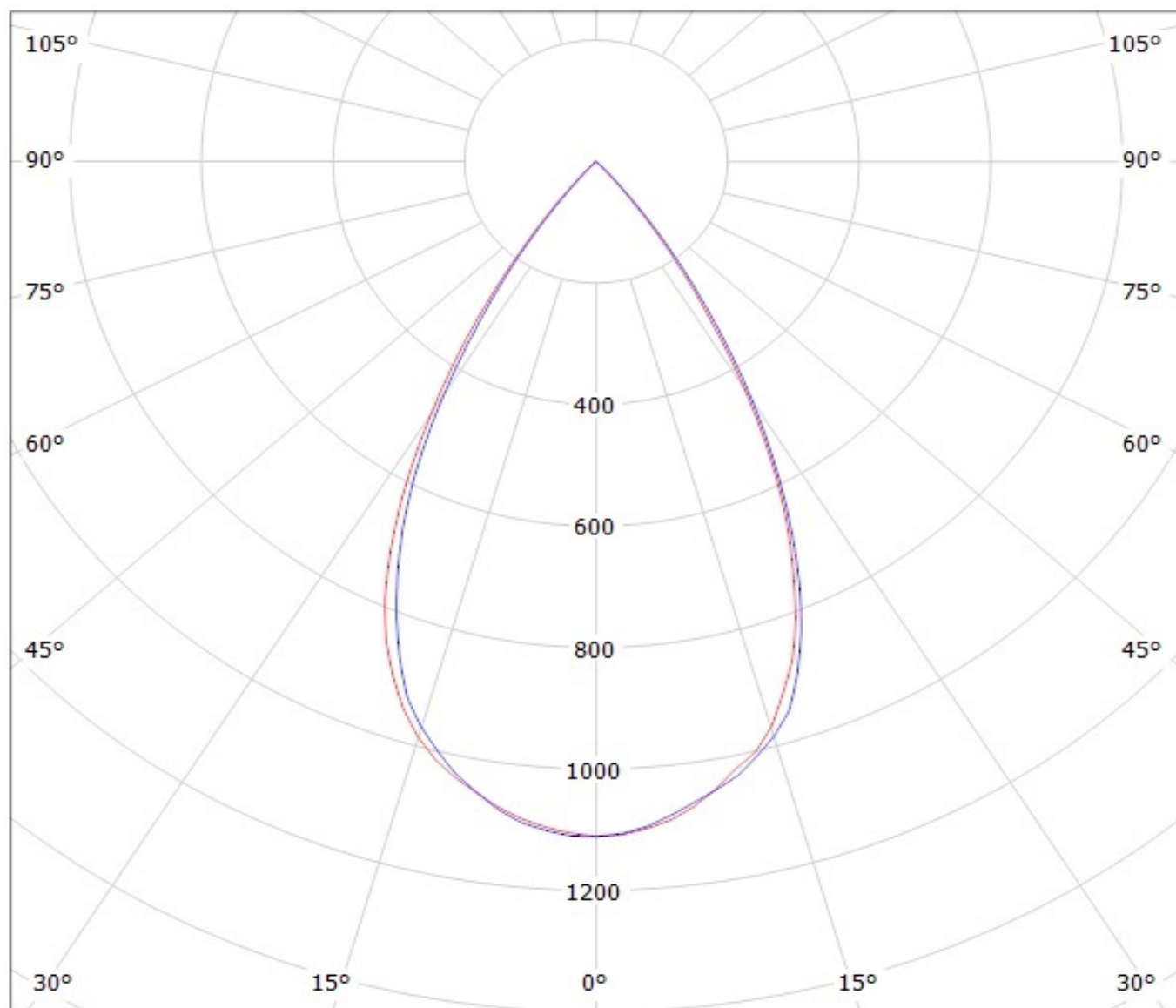

cd/klm

— C0 - C180

— C90 - C270

Luminaire: LEDiL Oy FCN13929_BARBARA-WW-PF-VERO13/18_(XENIO_13MM)
Lamps: 1 x XENIO_13MM_2074.66lm@?mA_P=23W_I=?A

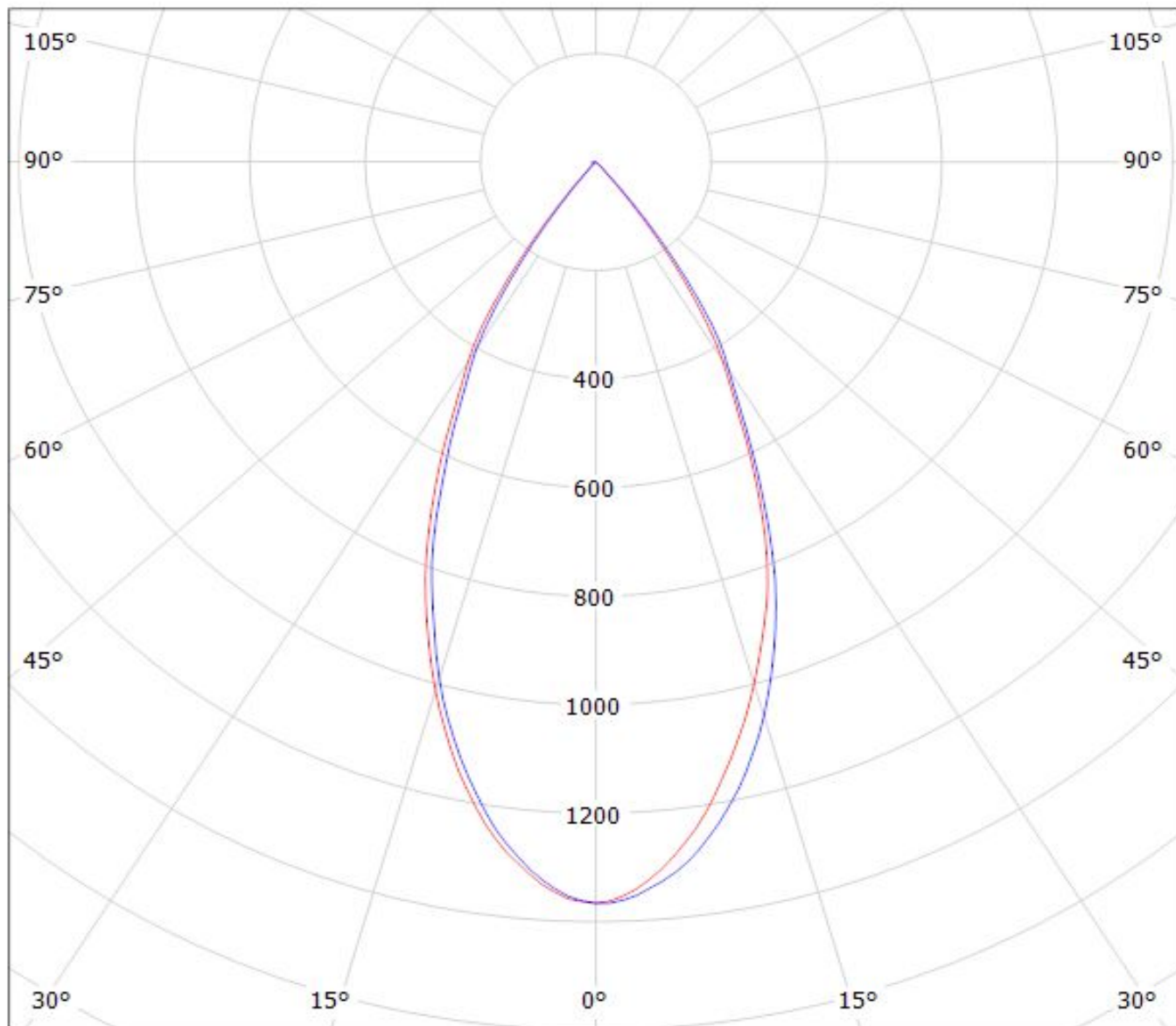

cd/klm

— C0 - C180 — C90 - C270

$\eta = 89\%$

Luminaire: LEDiL Oy FCN13929_BARBARA-WW-PF-VERO13/18_(Xenio_18mm)
Lamps: 1 x Xenio_18mm_3756.62lm@?mA_P=43W_I=?A

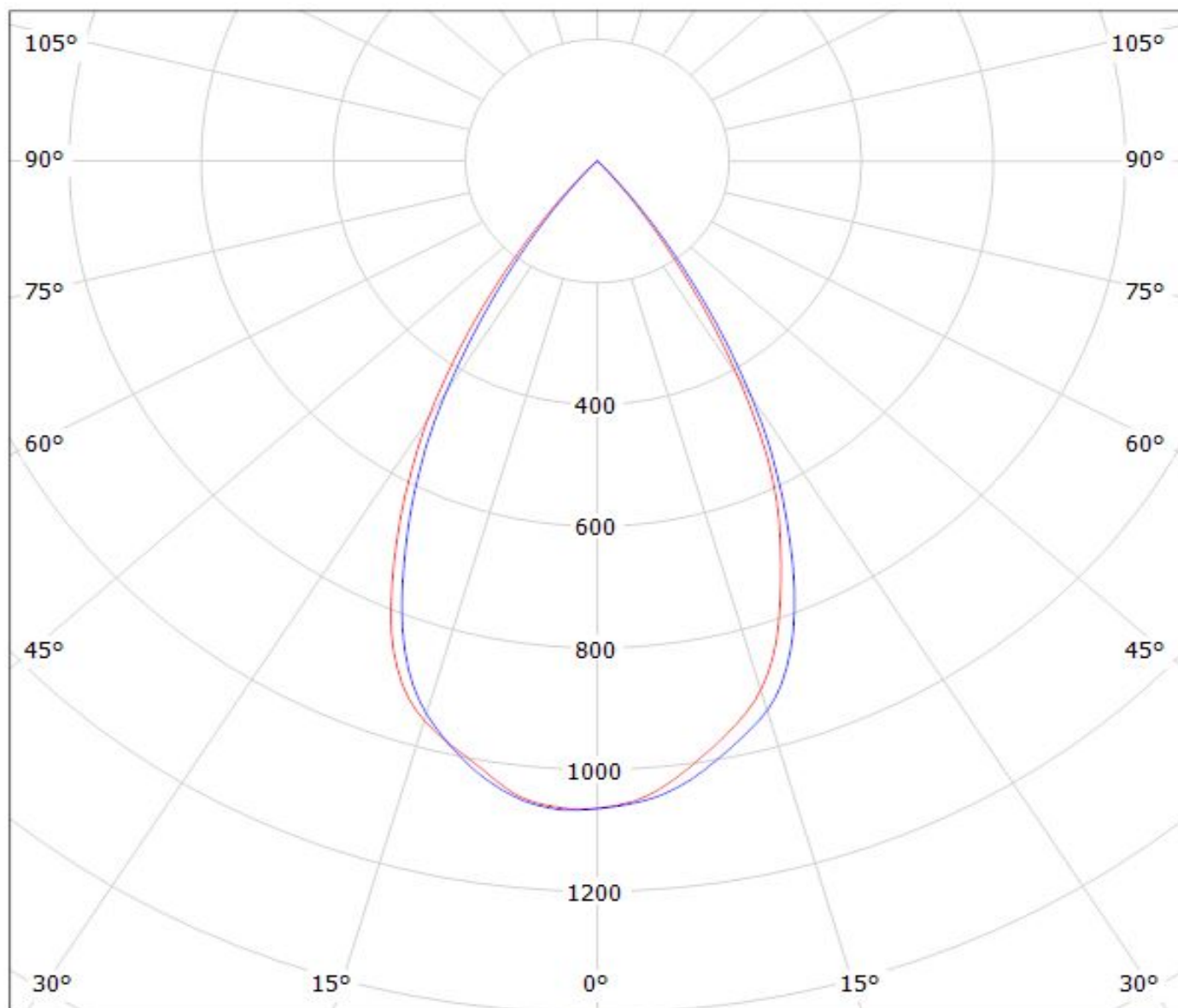

cd/klm

— C0 - C180

— C90 - C270

$\eta = 88\%$

Luminaire: LEDiL Oy FCN13929_BARBARA-WW-PF-VERO13-18_(CLU700)

Lamps: 1 x Citizen_CLU700_(CLU700-1002B8-273M2G1)_(C13709)_(434_Typ_L1)_374.62lm@100mA_P=2.81352W_I=0.1002A

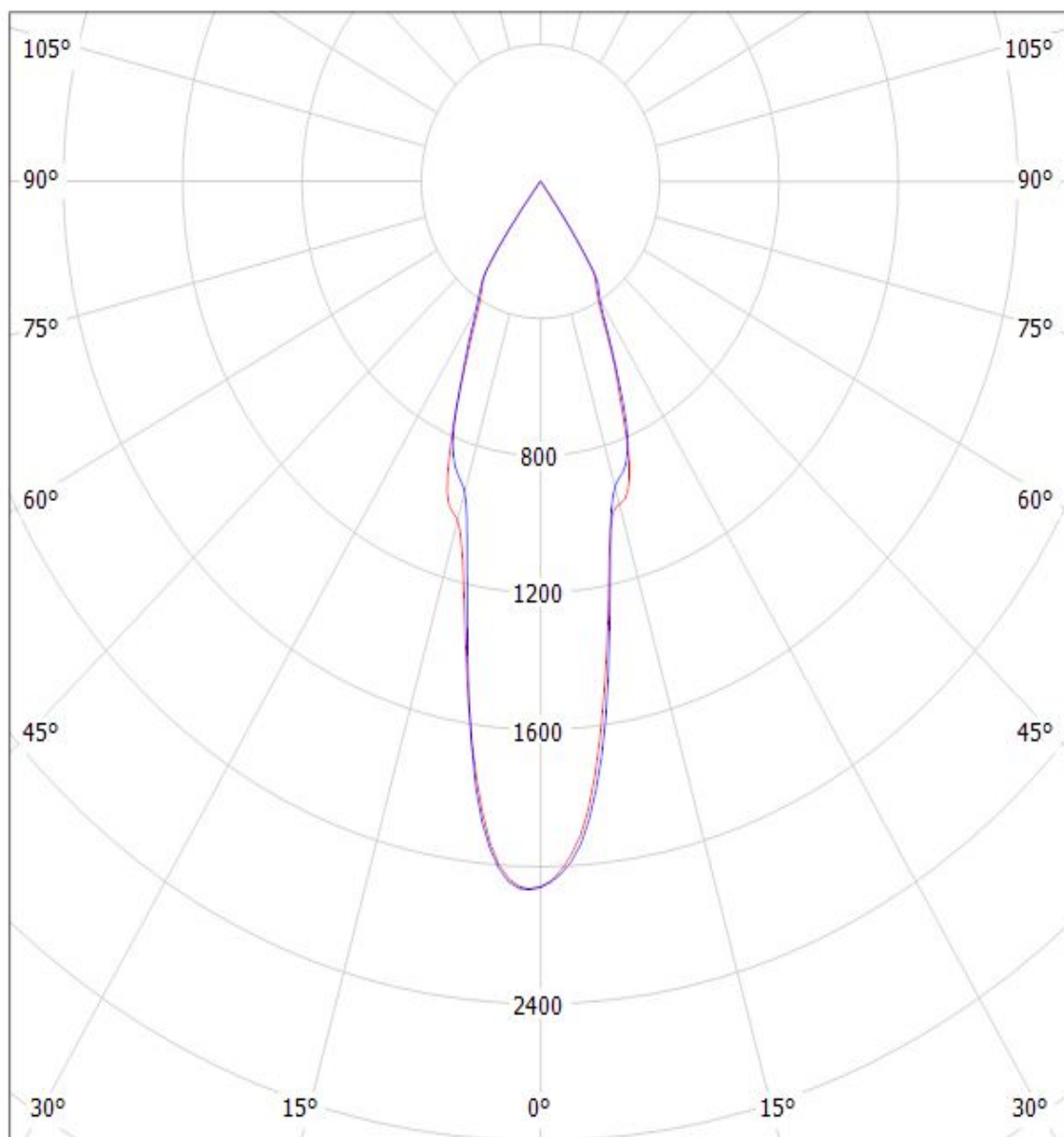

cd/klm

— C0 - C180 — C90 - C270

$\eta = 88\%$

Luminaire: Ledil FCN13929_BARBARA-WW-PF-VERO13/18_(CLU024) Citizen_CLU024_(434_Typ_L1)_
(C13709_PF-SOCKET-VERO13-18)_1065.5lm@250mA_P=8.55W_I=0.25A
Lamps: 1 x Citizen_CLU024_(434_Typ_L1)_ (C13709_PF-SOCKET-VERO13-18)
_1065.5lm@250mA_P=8.55W_I=0.25A

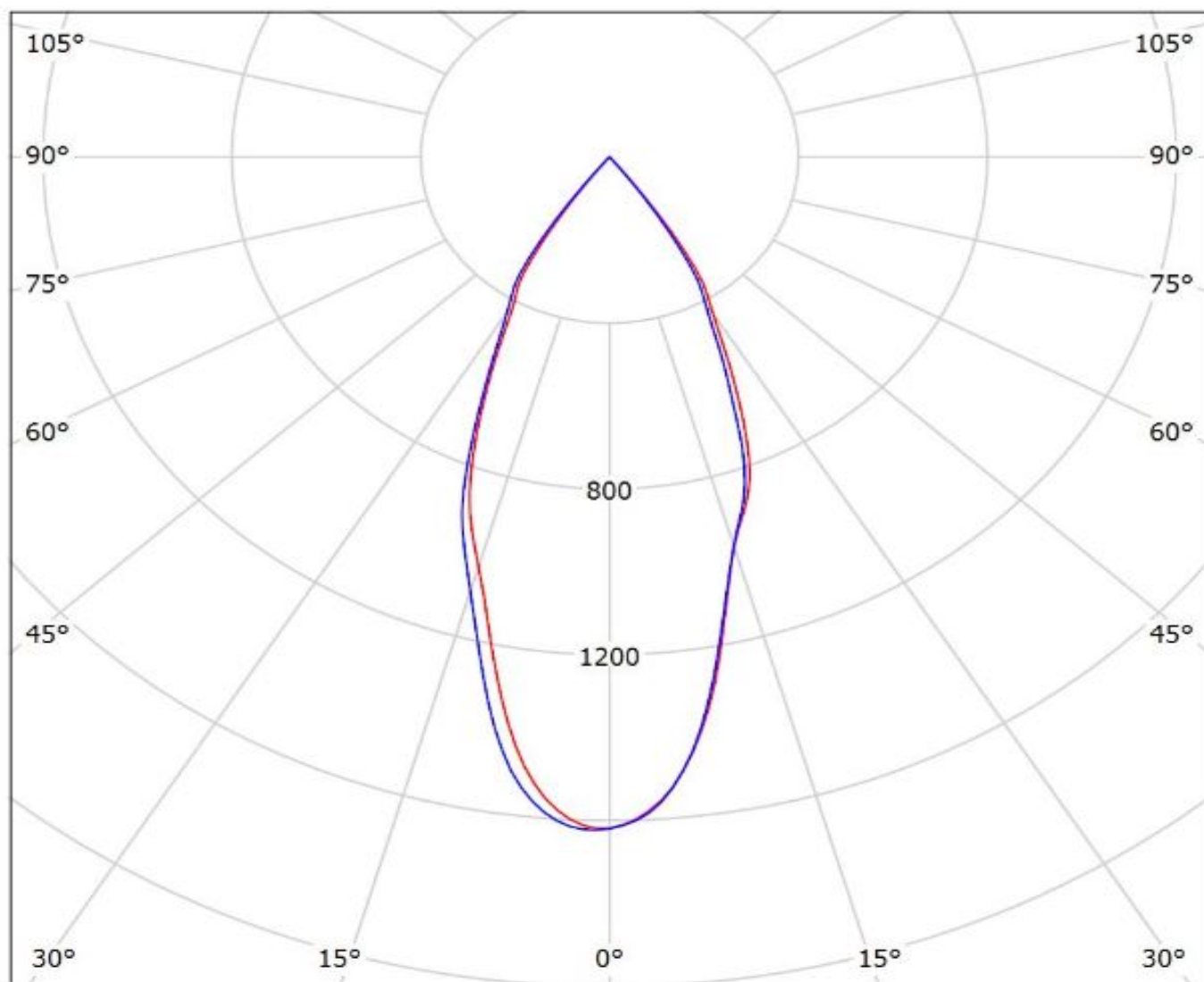

cd/klm
— C0 - C180 — C90 - C270

$\eta = 88\%$

Ledil FCN13929_BARBARA-WW-PF-VERO13-18_(CLU034)_(433_Typ_L1) / LDC (Polar)

Luminaire: Ledil FCN13929_BARBARA-WW-PF-VERO13-18_(CLU034)_(433_Typ_L1)

Lamps: 1 x Citizen_CLU034_(CLU034-1205B8-303M1A2)_1180.79lm@250mA_P=8.50075W_I=0.25A

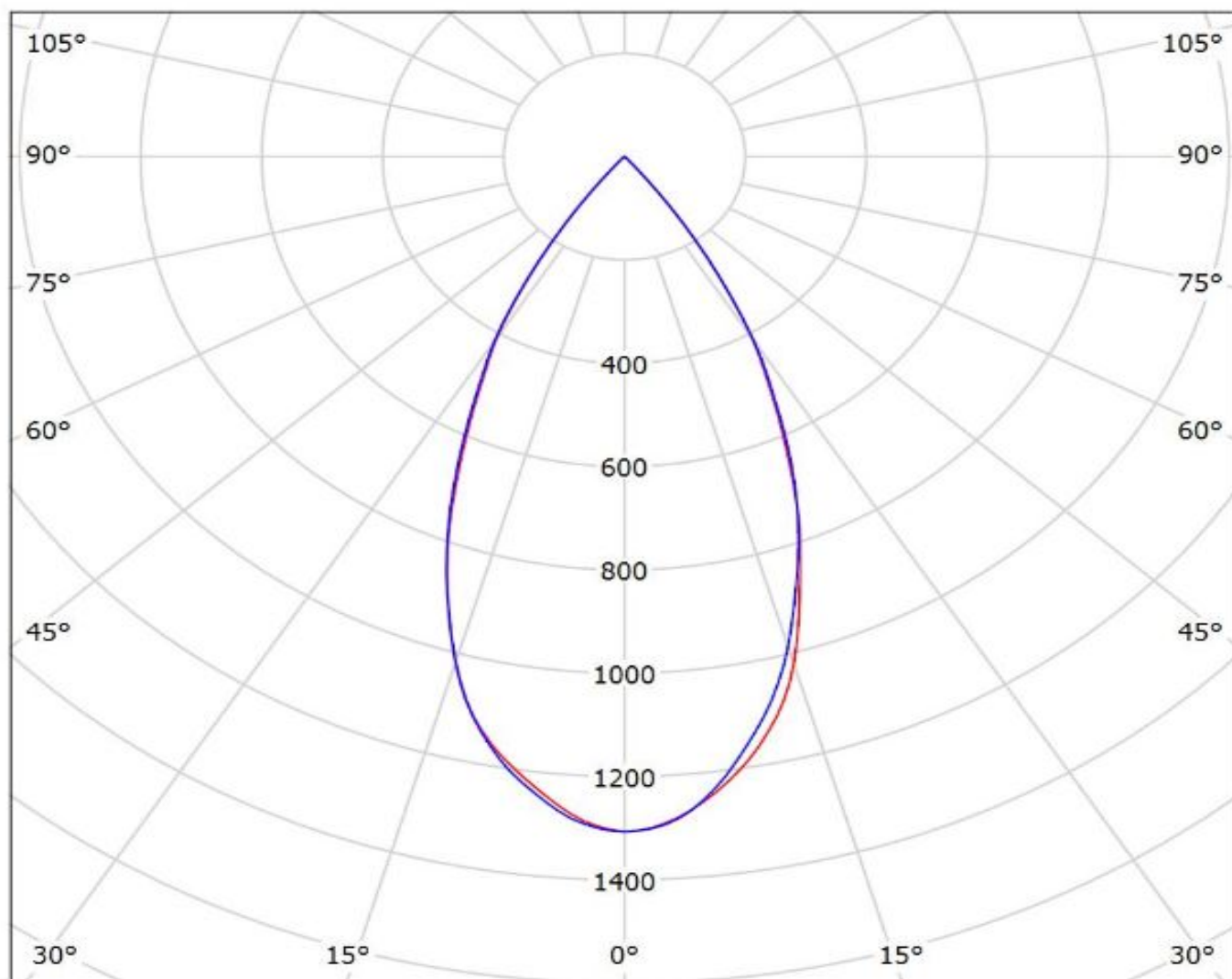

cd/klm

— C0 - C180

— C90 - C270

$\eta = 86\%$

Ledil FCN13929_BARBARA-WW-PF-VERO13-18_(CLU720)_(433_Typ_L1) / LDC (Polar)

Luminaire: Ledil FCN13929_BARBARA-WW-PF-VERO13-18_(CLU720)_(433_Typ_L1)
Lamps: 1 x Citizen_CLU720_(433_Typ_L1)_(C13709_PF-SOCKET-VERO13-18)
_1233.06lm@250mA_P=8.3W_I=0.25A

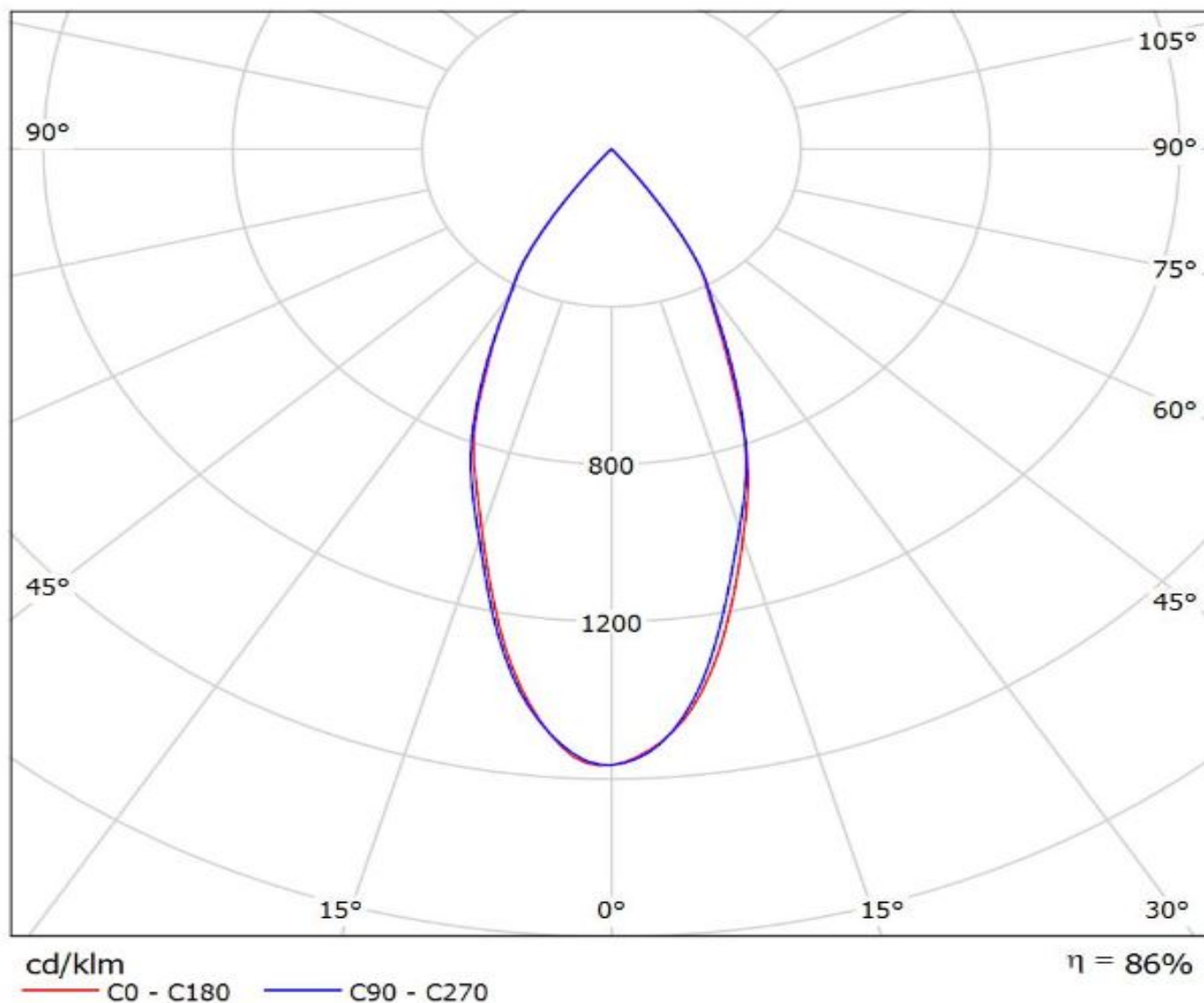

Ledil FCN13929_BARBARA-WW-PF-VERO13-18_(CXA1850) / LDC (Polar)

Luminaire: Ledil FCN13929_BARBARA-WW-PF-VERO13-18_(CXA1850)
Lamps: 1 x CREE_CXA1850_(CXA1850-30F-T4-N0Y-00001)
_847.836lm@250mA_CCT=3000K_P=8.27W_I=0.25A

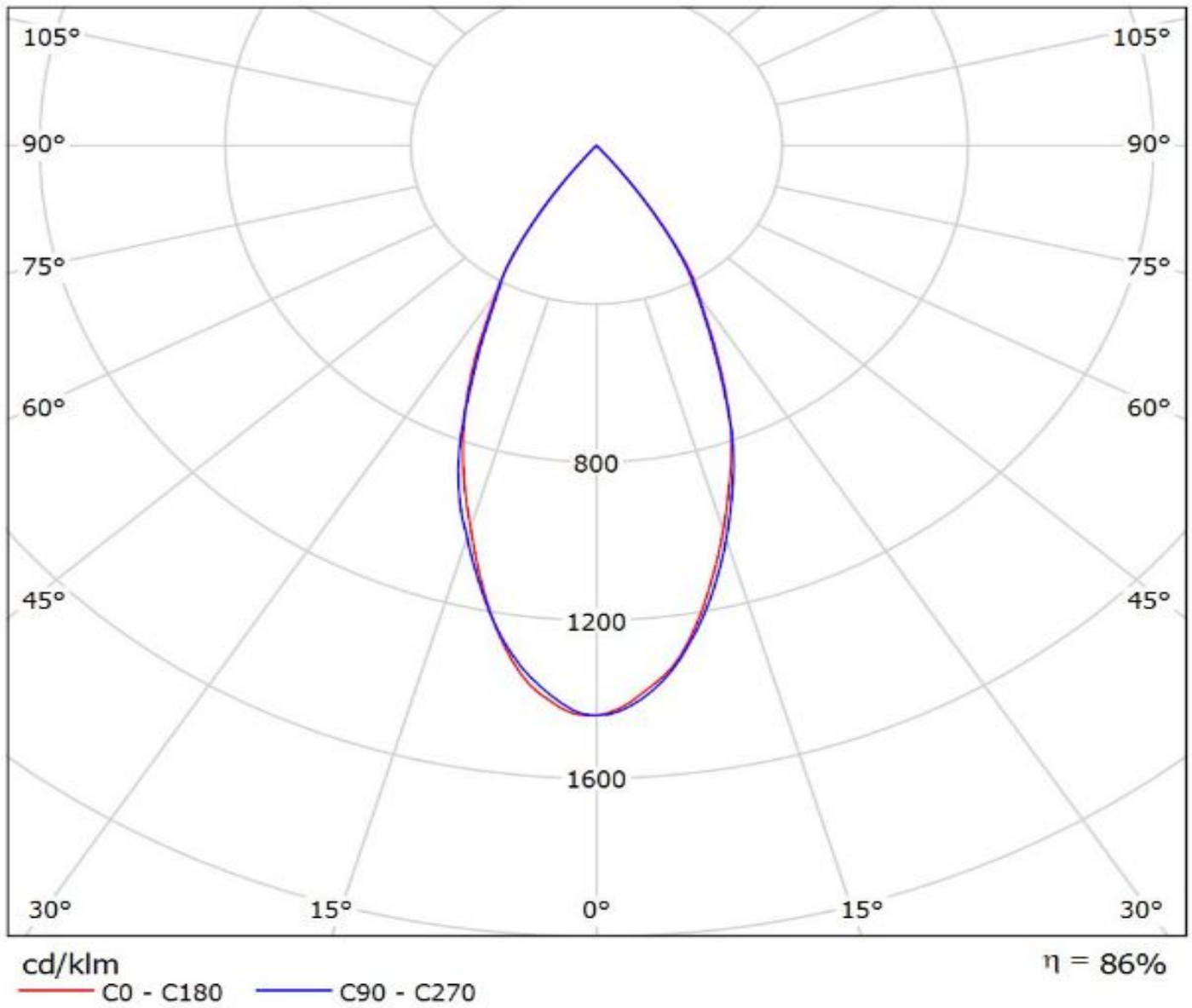

Luminaire: Ledil FCN13929_BARBARA-WW-PF-VERO13-18_(CXA1520) CXA1520_(CXA1520-30F-N4-N0H-00001)_(441_Typ_L1)_(C13709_PF-SOCKET-VERO13-18)_1036.14lm@250mA_P=8.825W_I=0.25A

Lamps: 1 x CXA1520_(CXA1520-30F-N4-N0H-00001)_(441_Typ_L1)_(C13709_PF-SOCKET-VERO13-18)_1036.14lm@250mA_P=8.825W_I=0.25A

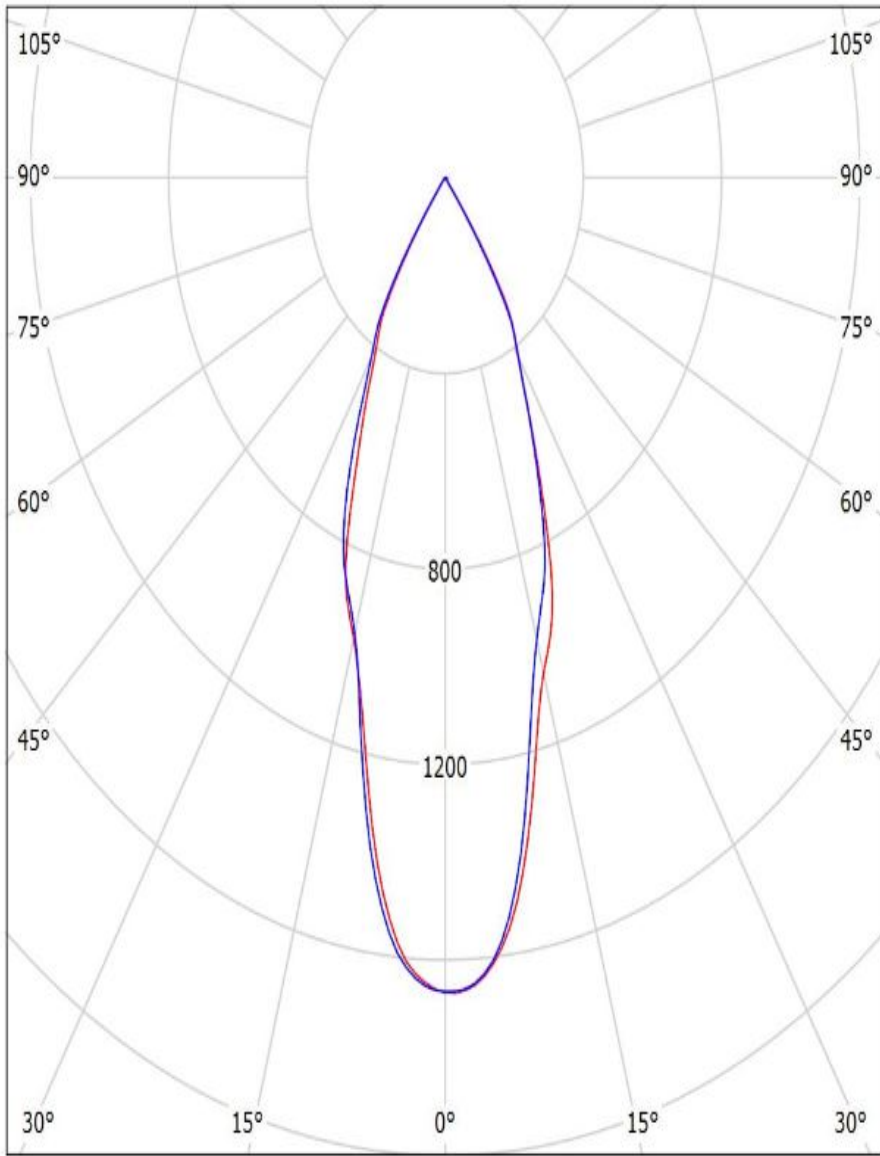

cd/klm

— C0 - C180 — C90 - C270

$\eta = 87\%$

Luminaire: LEDiL Oy FCN13929_BARBARA-WW-PF-VERO13-18_(Luxeon CoB 1203)

Lamps: 1 x Luxeon_COB_1203_(LHC1-3080-1203)_(C13868_LENA-STD-BASE-VERO13-18)_(438_Typ_L1)_990.381lm@250mA_P=8.6818W_I=0.2498A

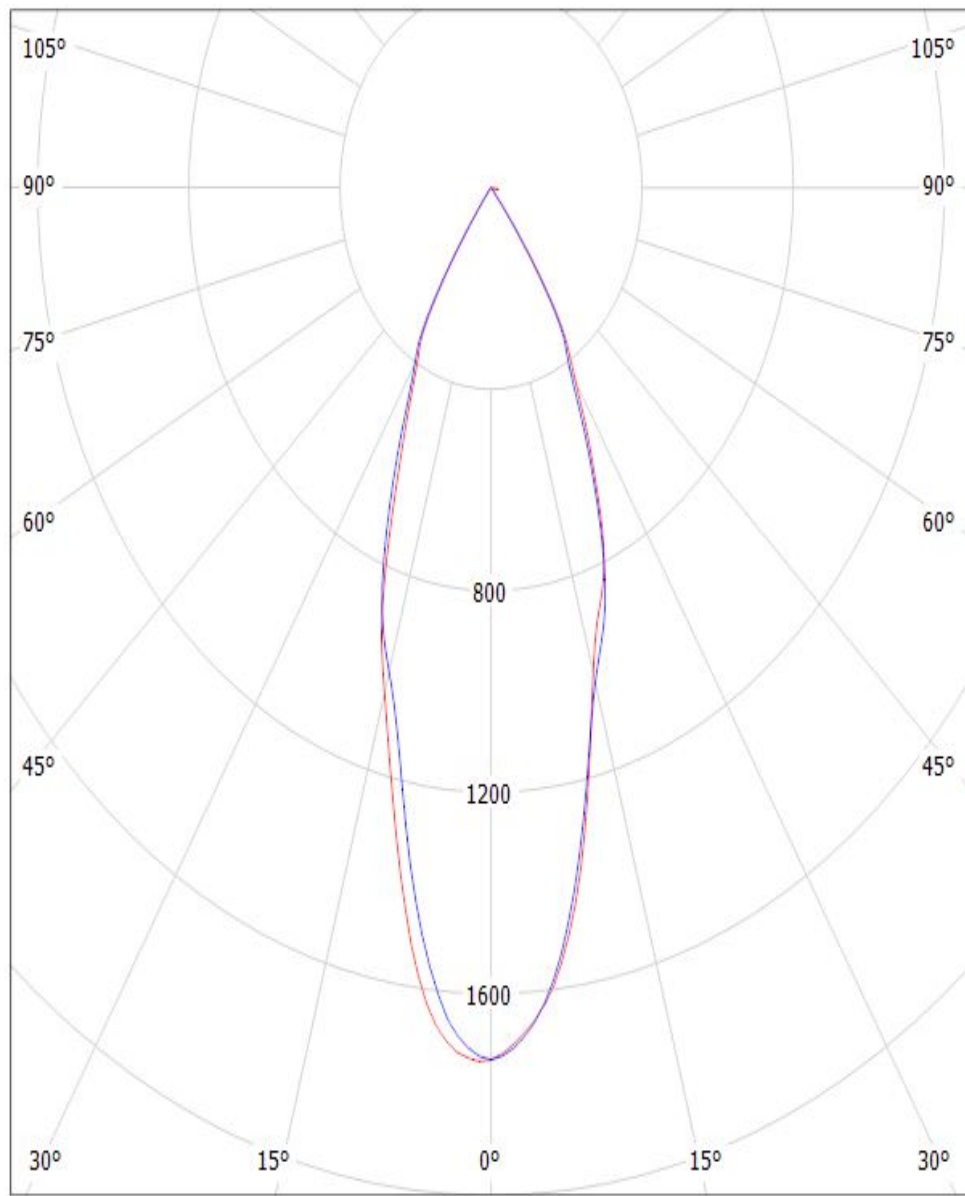

cd/klm

$\eta = 87\%$

— C0 - C180 — C90 - C270

Luminaire: LEDiL Oy FCN13929_BARBARA-WW-PF-VERO13-18_(NFCLL036B)

Lamps: 1 x Nichia NFCLL036B (sm403J1300R8000)_542.652lm@100mA_CCT=4000K_P=3.34084W_I=0.100A

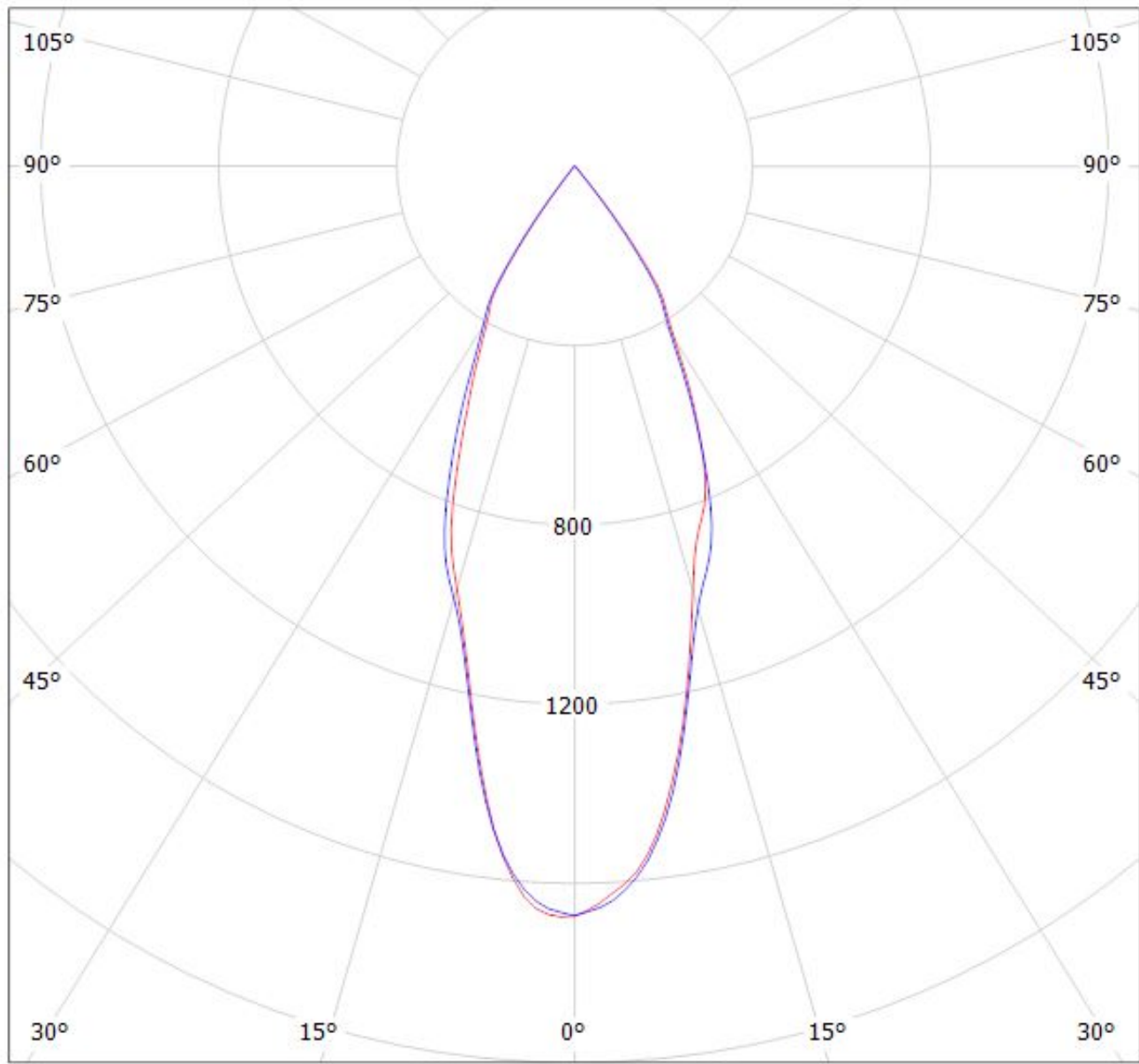

cd/klm

$\eta = 89\%$

— C0 - C180

— C90 - C270

Luminaire: Ledil FCN13929_BARBARA-WW-PF-VERO13/18_(NFDxJ130B)
Lamps: 1 x Nichia_NFDxJ130B_(463 Typ L2)_C13709_PF-SOCKET-VERO13-18_1532.05lm@250mA_P=8.27W_I=0.25A

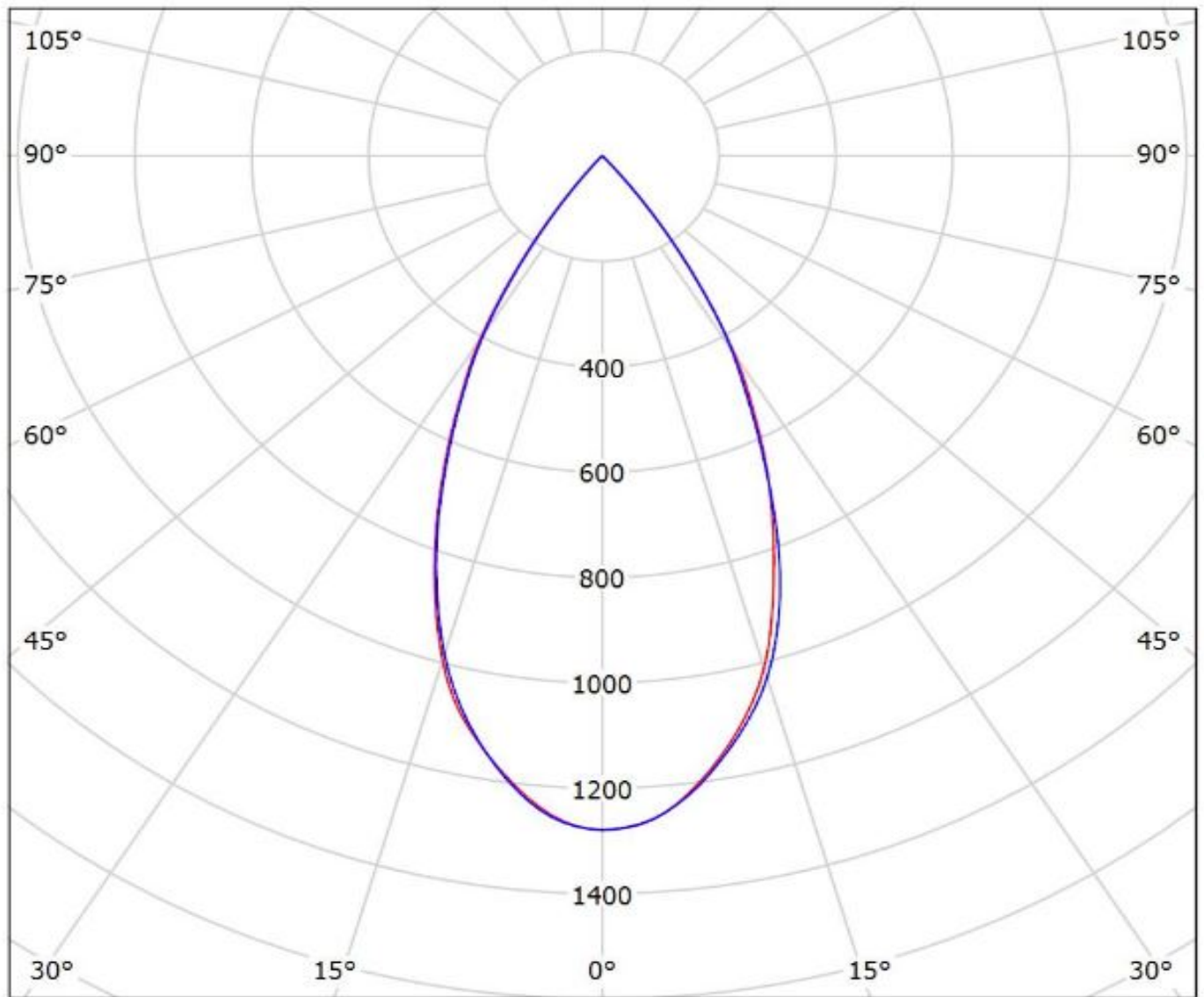

cd/klm

— C0 - C180 — C90 - C270

$\eta = 86\%$

Luminaire: Ledil FCN13929_BARBARA-WW-PF-VERO13/18_(NFCLL060B)

Lamps: 1 x Nichia_NFCLL060B_(438_TYP_L1)_1365.88lm@250mA_P=8.375W_I=0.25A

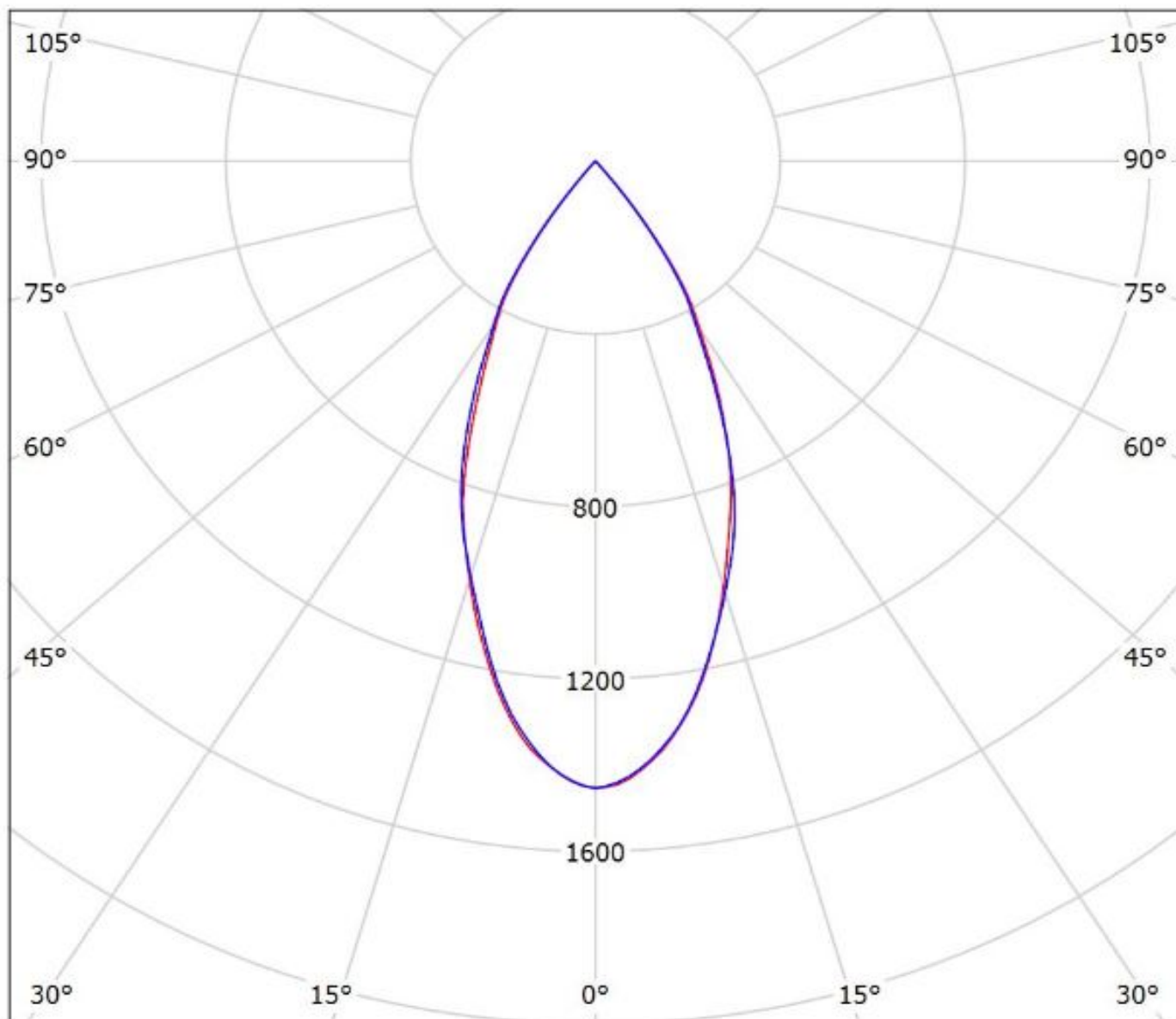

cd/klm

— C0 - C180 — C90 - C270

$\eta = 87\%$

Luminaire: LEDiL Oy FCN13929_BARBARA-WW-PF-VERO13/18_(Soleriq_P9)_Bender+Wirth_connector_461
Lamps: 1 x Osram_Soleriq_P9_(GQ_MAFJB1.EM)_875.631lm@250mA_P=6.94894W_I=0.2498A

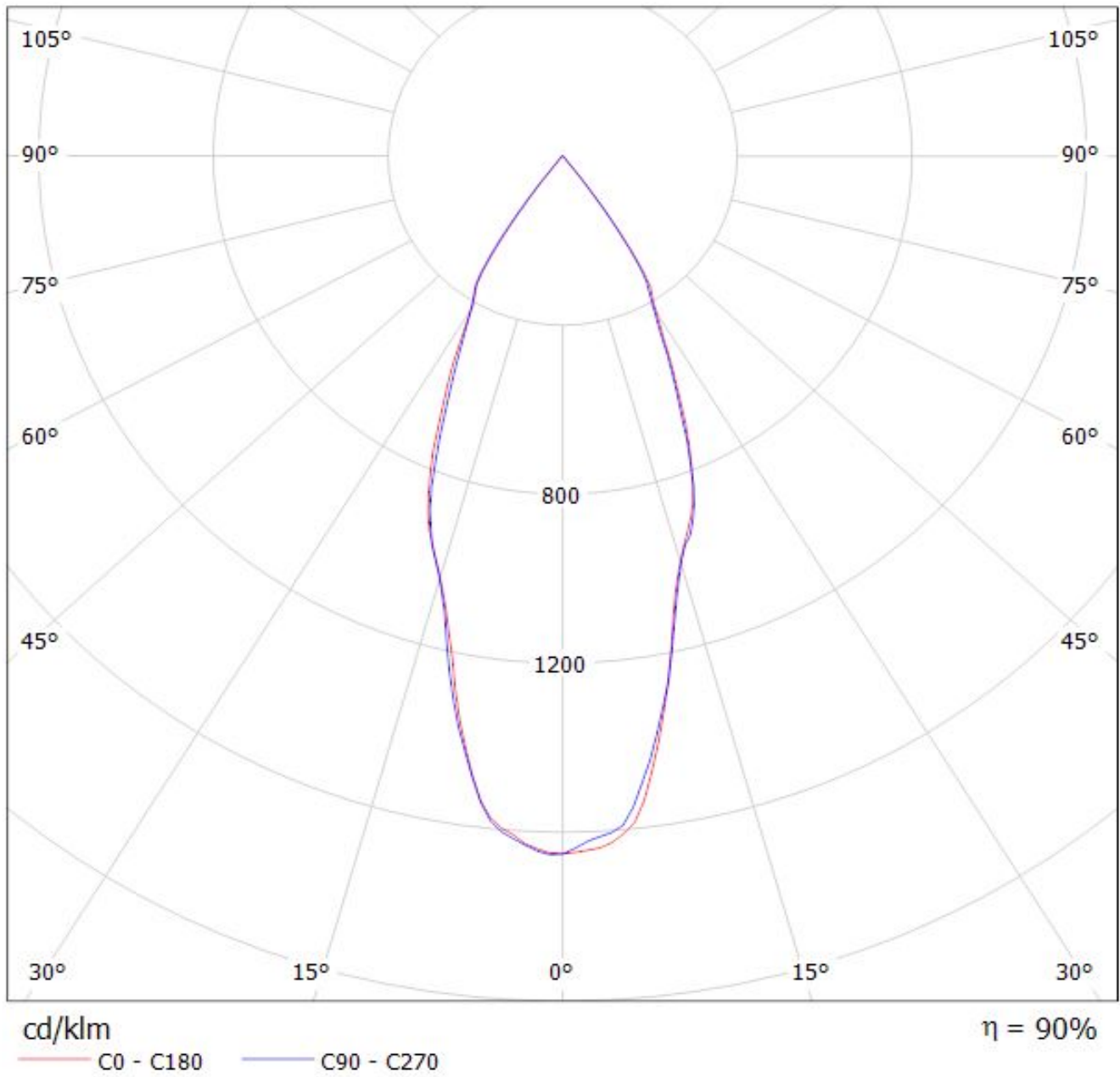

Luminaire: LEDiL Oy FCN13929_BARBARA-WW-PF-VERO13/18_(Soleriq P13)
Lamps: 1 x Osram Soleriq P13 (GW MAGMB1.EM)_921.649lm@250mA_CCT=3500K_P=8.8097W_I=0.25A

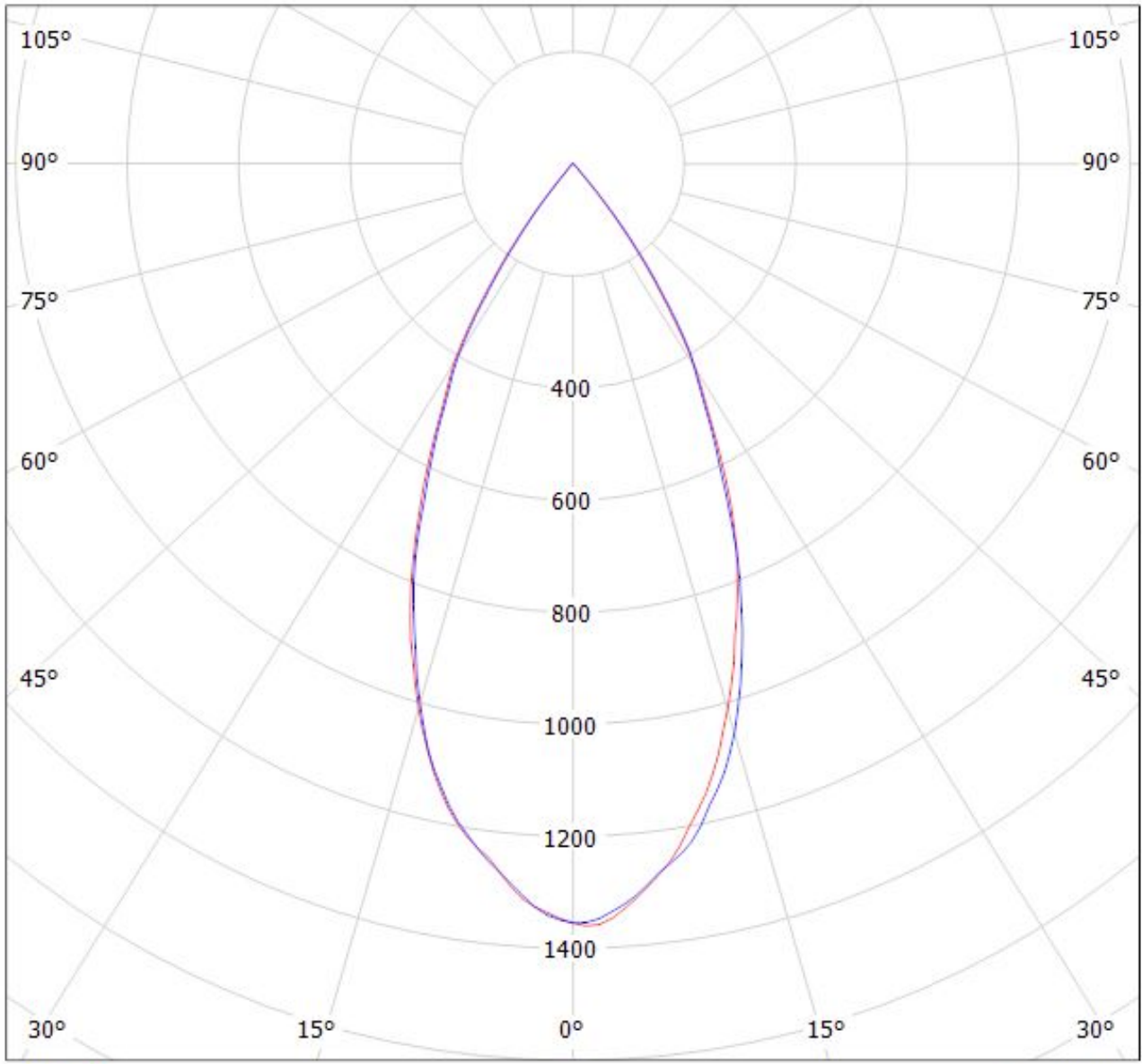

cd/klm η = 88%
— C0 - C180 — C90 - C270

Luminaire: Ledil FCN13929_BARBARA-WW-PF-VERO13-18_(Soleriq_S13)

Lamps: 1 x Osram_Soleriq_S13_(GW_KAGHB1.EM)_931.029lm@250mA_P=7.44679W_I=250mA

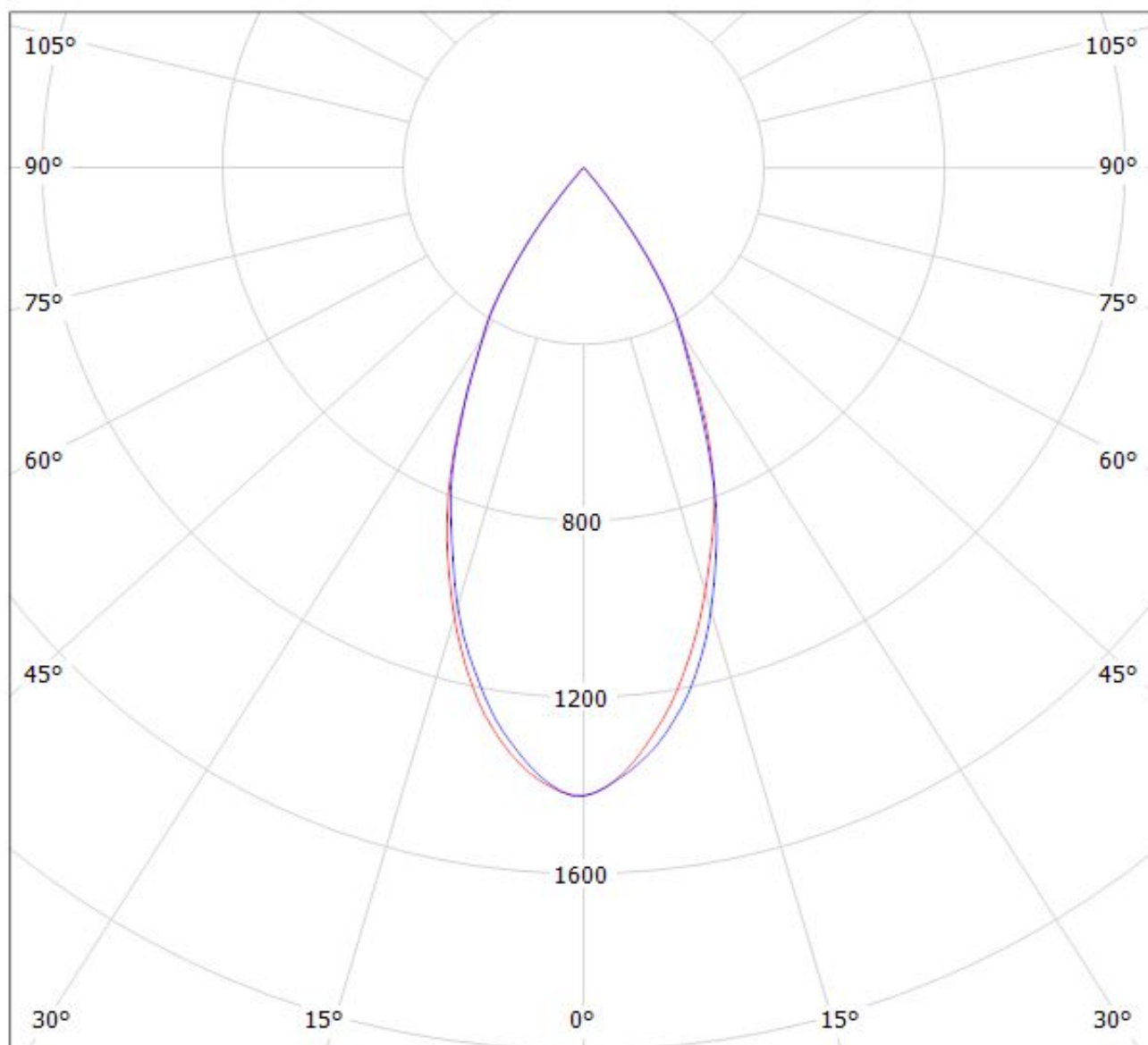

cd/klm

— C0 - C180

— C90 - C270

$\eta = 87\%$

Luminaire: Ledil FCN13929_BARBARA-WW-PF-VERO13/18_(LC040B)_(450_Typ_L2)_(C13709)
Lamps: 1 x Samsung_LC040B_(SPHWW1HDNE25010101)_CCT=3000k_(450_Typ_L2)_(C13709_PF-SOCKET-VERO13-18)_1115.79lm@250mA_P=8.075W_I=0.25A

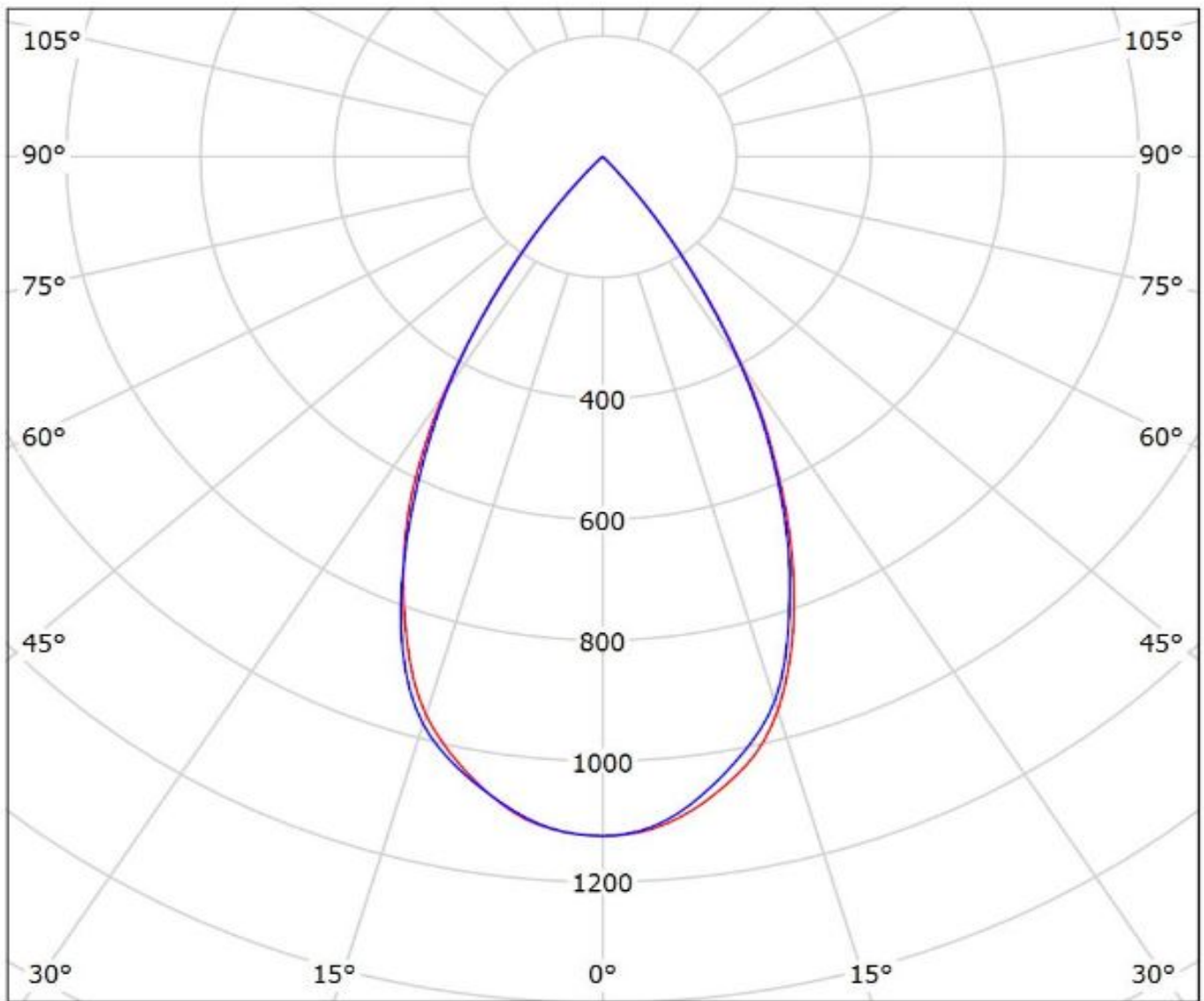

cd/klm

— C0 - C180 — C90 - C270

$\eta = 86\%$

Luminaire: LEDiL Oy FCN13929_BARBARA-WW-PF-VERO13/18_(SLE-G5_LES-11)
Lamps: 1 x Tridonic_SLE-G5_LES-11_1142.55lm@250mA_P=8.4070W_I=0.250A

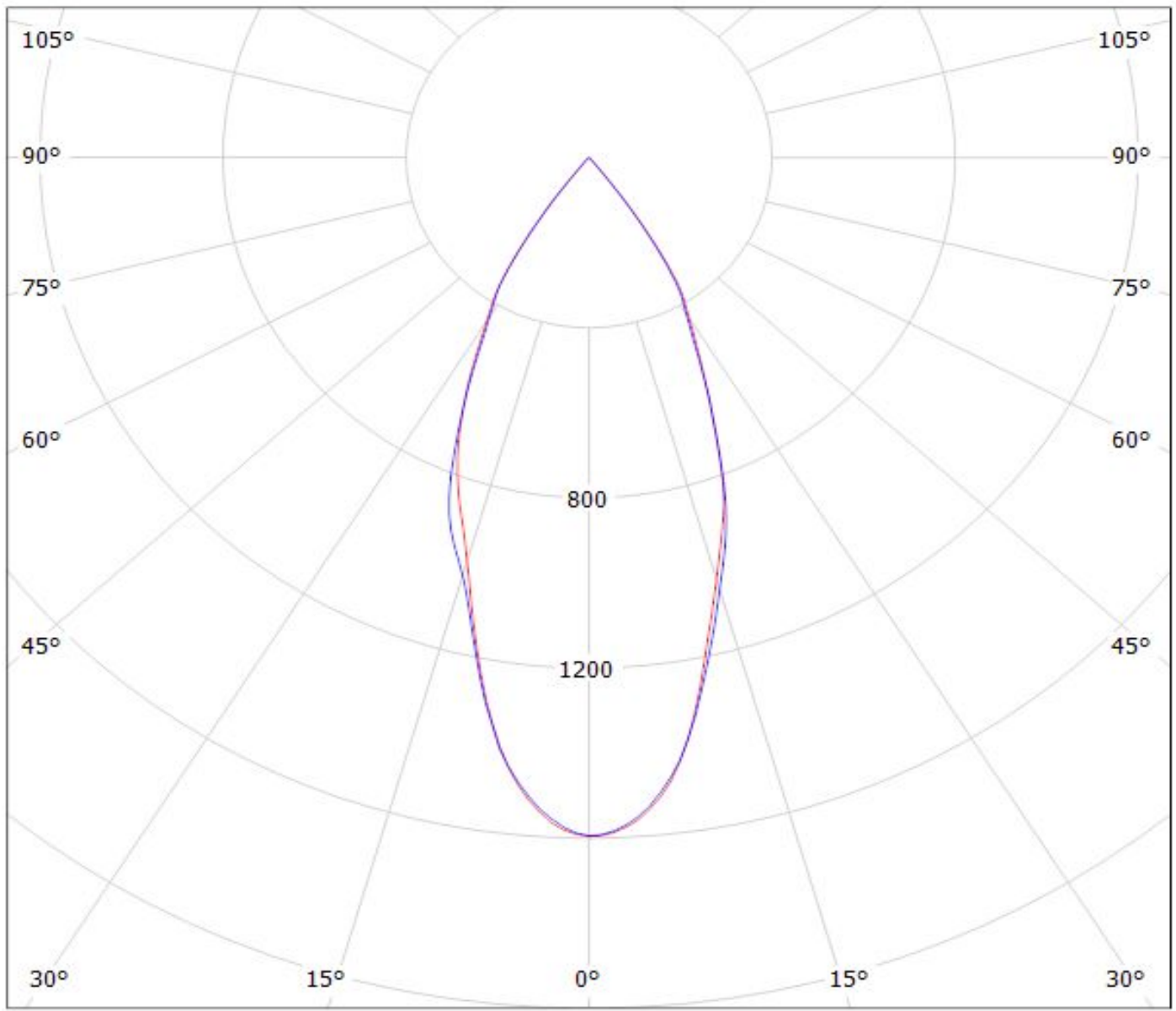

cd/klm

— C0 - C180 — C90 - C270

$\eta = 89\%$

NOTE: The typical divergence will be changed by different color, chip size and chip position tolerance. The typical total divergence is the full angle measured where the luminous intensity is half of the peak value.

GENERAL INFORMATION

- Product series especially designed & optimized for series of LEDs.
- Special care taken to make light distribution as uniform as possible.

Note! Due to use of high power COB's with this product, special attention to proper thermal design is highly recommended. LEDiL has no liability for direct, indirect or consecutive damages arising from the LEDiL products being used outside of the recommended temperature range.