



Grayhill, Inc.

62S11-L0-020CH

Dalis numeris: 62S11-L0-020CH

Gamintojas / Gamintojas: Grayhill, Inc.

Prekės aprašymas: ROTARY ENCODER OPTICAL 32PPR

Duomenų lapai:  62S11-L0-020CH.pdfRoHS statusas:  Švinas nemokamai / RoHS atitiktis

Akcijų būklė: 2105 pcs stock

Laivas iš: Honkongas

Siuntimo būdas: DHL/Fedex/TNT/UPS/EMS

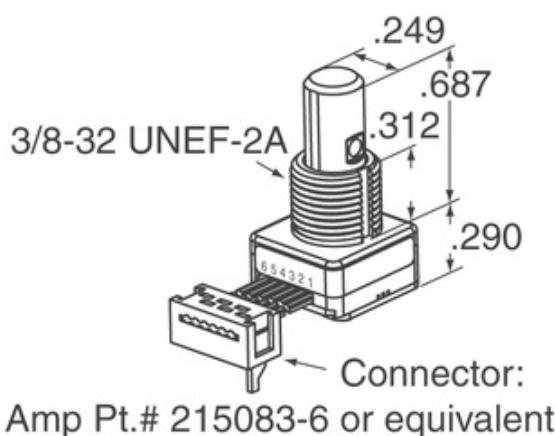

Vaizdas gali būti atvaizdavimas. Žr. Produkto detalių specifikacijas.

PRAŠYMAS KOTIRUOTI



62S11-L0-020CH specifikacijos

DALIES NUMERIS	62S11-L0-020CH
GAMINTOJAS	Grayhill, Inc.
APIBŪDINIMAS	ROTARY ENCODER OPTICAL 32PPR
"LEAD FREE STATUS / ROHS" STATUSAS	Švinas nemokamai / RoHS atitiktis
GALIMAS KIEKIS	2105 pcs
DUOMENŲ LAPAS	 62S11-L0-020CH.pdf
ĮTAMPA - TIEKIMAS	5V
NUTRAUKIMO STILIUS	Cable with Connector
SERIJA	62S
ROTATIONAL LIFE (CYCLES MIN)	1M
IMPULSAI PER REVOLIUCIJĄ	32
IŠVESTIES TIPAS	Quadrature (Incremental)
KITI VARDAI	62S11L0020CH
ORIENTACIJA	Vertical
MONTAVIMO TIPAS	Panel Mount
DRĖGMĖS JAUTRUMO LYGIS (MSL)	1 (Unlimited)
"LEAD FREE STATUS / ROHS" STATUSAS	Lead free / RoHS Compliant
KODAVIMO TIPAS	Optical
DETENT	Yes
PASTATYTAS JUNGIKLIS	No
PAVAROS TIPAS	1/4" Dia Flatted End

Susijusios žymės

Grayhill, Inc. 62S11-L0-020CH	62S11-L0-020CH platintojas	62S11-L0-020CH tiekėjas
62S11-L0-020CH Kaina	62S11-L0-020CH Nuotraukos	62S11-L0-020CH vaizdas
62S11-L0-020CH PDF duomenų lapas	62S11-L0-020CH Atsisiųsti duomenų lapą	62S11-L0-020CH duomenų lapas
62S11-L0-020CH atsargos	Pirkite 62S11-L0-020CH	Pirkti Grayhill, Inc. 62S11-L0-020CH
Grayhill, Inc. 62S11-L0-020CH	Grayhill, Inc. tiekėjas	Grayhill, Inc. platintojas
Grayhill, Inc. 62S11-L0-020CH	Grayhill Inc. 62S11-L0-020CH	

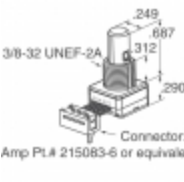
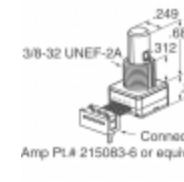
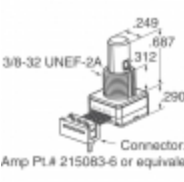
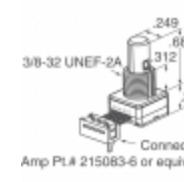
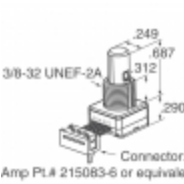
Susiję produktai

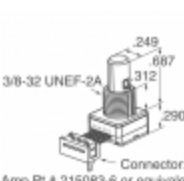
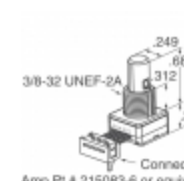
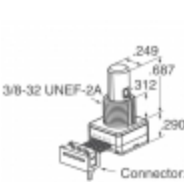
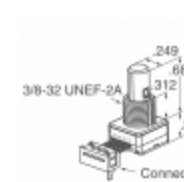
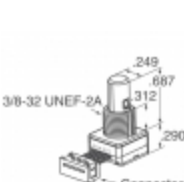
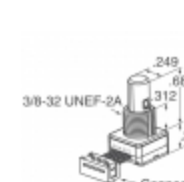
 <p>62S11-H9-P Gamintojai: Grayhill, Inc. apibūdinimas: ROTARY ENCODER OPTICAL 32PPR Sandelyje: 2159 pcs</p> <p>RFQ</p>	 <p>62S11-L0-060S Gamintojai: Grayhill, Inc. apibūdinimas: ROTARY ENCODER OPTICAL 32PPR Sandelyje: 2241 pcs</p> <p>RFQ</p>
 <p>62S11-H9-PH Gamintojai: Grayhill, Inc. apibūdinimas: ROTARY ENCODER OPTICAL 32PPR Sandelyje: 2090 pcs</p> <p>RFQ</p>	 <p>62S11-L0-020C Gamintojai: Grayhill, Inc. apibūdinimas: ROTARY ENCODER OPTICAL 32PPR Sandelyje: 1839 pcs</p> <p>RFQ</p>
 <p>62S11-L0-055C Gamintojai: Grayhill, Inc. apibūdinimas: ROTARY ENCODER OPTICAL 32PPR Sandelyje: 1995 pcs</p> <p>RFQ</p>	 <p>62S11-L0-040S Gamintojai: Grayhill, Inc. apibūdinimas: ROTARY ENCODER OPT 32PPR 4" CBL Sandelyje: 2058 pcs</p> <p>RFQ</p>
 <p>62S11-H9-060SH Gamintojai: Grayhill, Inc. apibūdinimas: ROTARY ENCODER OPTICAL 32PPR Sandelyje: 1966 pcs</p> <p>RFQ</p>	 <p>62S11-L0-040C Gamintojai: Grayhill, Inc. apibūdinimas: ROTARY ENCODER OPTICAL 32PPR Sandelyje: 2079 pcs</p> <p>RFQ</p>
 <p>62S11-H9-050S Gamintojai: Grayhill, Inc. apibūdinimas: ROTARY ENCODER OPTICAL 32PPR Sandelyje: 1839 pcs</p> <p>RFQ</p>	 <p>62S11-H9-060C Gamintojai: Grayhill, Inc. apibūdinimas: ROTARY ENCODER OPTICAL 32PPR Sandelyje: 2172 pcs</p> <p>RFQ</p>
 <p>62S11-L0-060SH Gamintojai: Grayhill, Inc. apibūdinimas: ROTARY ENCODER OPTICAL 32PPR Sandelyje: 2073 pcs</p> <p>RFQ</p>	 <p>62S11-L0-060CH Gamintojai: Grayhill, Inc. apibūdinimas: ROTARY ENCODER OPTICAL 32PPR Sandelyje: 1935 pcs</p> <p>RFQ</p>

Copyright © 2020 patikimas elektroninių komponentų platintojas

El. Paštas: Info@infinity-electronic.com

Adresas: 17F, Gaylord komercinis pastatas, 114-118 Lockhart kelias, Wan Chai, Honkongas

